



Wide Range of Products for Every Need



For more information give **MISSED CALL: 07676065555**



Many of our products have BIS: ISI certification.



|  |  |  |  |
|--|--|--|--|
| Product                                    | <b>Shoulder Mounted Baffle Type Reaper</b> | KisanKraft Invoice Date  |  |
| Brand                                      | <b>KisanKraft</b>                          | KisanKraft Invoice No.   |  |
| Model                                      | <b>KK-SBC-4502, KK-SBC-3804</b>            |  |  |
| <b>WARRANTY PERIOD</b>                     | <b>6 MONTHS</b>                            | FOR THE SPECIFIED PERIOD FROM THE DATE OF SALE OR DELIVERY WHICHEVER IS EARLIER. |  |
| Dealer's Invoice Date                      |  | Dealer's Invoice No.   |  |
| Buyer's Info (Name, Address, Phone, etc.): |  | Dealer's Stamp (Address, Phone, TIN, etc.):                                      |  |
| Buyer's Sign                               |  | Dealer's Sign  |  |

**Warranty Policy**

**What is covered:** KisanKraft Limited and its manufacturers warrant this product to be free from defects in material or workmanship. All parts defective in material and workmanship are covered.

This warranty will only cover defects arising under normal usage.

This warranty is limited to repair or replacement by KisanKraft Limited or its manufacturers of such parts as appear to KisanKraft or its manufacturers, upon inspection, to be defective in material and/or workmanship. KisanKraft or its manufacturers make no warranty with respect to items not manufactured or sold by them. No onsite warranty is provided by KisanKraft Limited or its manufacturers. Defective items must be brought/sent to our Authorized Dealer or KisanKraft Limited's office for service.

**What is not covered:** The *warranty shall become null and void* and neither KisanKraft Limited nor any of its manufacturers, nor its authorized dealers assumes any responsibility, if the failure was caused by the following:

- (1) Operation of product with incorrect fuel or lubricants, (2) Incorrect usage of machine or misuse, (3) Lack of maintenance, (4) Negligence, (5) Accident or physical damage, (6) Repairs made by unauthorized parties and/or with unauthorized parts, (7) Improper set up, adjustments, tampering or altered products (8) Any modification to the product what-so-ever.

**Important:** (1) Normal maintenance and adjustments to the product is the responsibility of the customer. (2) Normal wear and tear are not covered under warranty. (3) Rubber/plastic parts and consumables such as blades, clutch and clutch-bell, sparkplugs, nylon line, air-filters, fuel-filters, oil seals and gaskets etc. are not covered under the warranty. (4) Electrical Motor, Electrical Parts, Battery Etc. are not covered under the warranty.

**This warranty is null & void, if you fail to register the warranty with KisanKraft by sending the KisanKraft Copy with dealer's stamp.**

**Incidental / Consequential Loss:** KisanKraft Limited or its manufacturers will not be liable for general damages, including bodily injuries, or for incidental or consequential damages including, but not limited to, loss of use, loss of profits, loss of production, expense of substitute equipment or other commercial loss or damage.

**Limitation of Liability:** This limited warranty is in lieu of all other express warranties, obligations, or liabilities. Any implied warranties, obligations or liabilities, including, but not limited to, any implied warranty of merchantability shall be limited in duration to the applicable warranty period. Any action for breach of any warranties hereunder, including, but not limited to, any implied warranty of merchantability must be brought within the applicable warranty period.

**Modifications of Warranty:** No agent, representative, dealer, or employee of KisanKraft Limited or any of its manufacturers has the authority to increase or alter the obligations of this warranty.

**Assignment / Transfer of warranty:** The warranty cannot be assigned and shall not transfer if the product is resold by the first buyer. The above warranties are extended to the first end user (original purchaser), and no warranty is made, nor authorized to be made assignable on resale by the first end user.

**What you must do to obtain limited warranty service:** To obtain performance of any obligation under this warranty for failure during the applicable warranty period, you must deliver the defective product, to the nearest Authorized Dealer, along with proof-of-purchase (invoice/receipt). KisanKraft Limited, its manufacturers and its dealers reserve the right to inspect the claimed defective part(s) to determine if the malfunction is the result of a defect covered by this warranty. Please note that the decision of KisanKraft Limited with respect to any warranty claim is final.

**After-sales Service (Including Warranty):** KisanKraft Limited does not sell directly to consumers. All sales or supplies are made through Authorized Dealers. It is the responsibility of the Authorized Dealer to provide all after-sales service to consumers. Any warranty claim should be raised by dealer to KisanKraft Limited as per warranty policy.

**Jurisdiction:** All disputes are subject to Bangalore court's jurisdiction.

**Notes:**

- This purchase is not contingent upon a product demonstration. The purchaser shall satisfy himself with the product, including any product demonstration or verification of any function, before buying. KisanKraft Limited or its authorized dealers, including online sellers, shall not be liable to give any on-site demonstration after purchase of any of the product.
- Any product once used will not be taken back by KisanKraft Limited.
- Warranty and After Sale Services (including but not limited to installation, Demonstration, Repair, Routine Maintenance etc.), should be done through the Authorized Dealer selling this product.
- Dealers should have their own technician to provide After Sales Services to their Customers. KisanKraft Limited provides free training to Authorized Dealer's technicians at KisanKraft Limited's head office, on request from Authorized Dealer.

**KisanKraft has a large range of products to serve the farmers. A list of our products is given below:**

|  |   |
|--|---|
| <p><b>Brush Cutters and Accessories</b></p> <ul style="list-style-type: none"> <li>Brush Cutter/Power Weeder</li> <li>Backpack Brush Cutter</li> <li>Tea Pruner</li> <li>Pole pruner with Engine</li> <li>Reaper Attachment</li> <li>Blades-Circular</li> <li>Blades (2 &amp; 3 points)</li> <li>Baffle</li> <li>Nylon Rope</li> <li>Tap &amp; Go</li> </ul> <p><b>Chainsaws</b></p> <ul style="list-style-type: none"> <li>Petrol Chainsaw</li> <li>Electric Chainsaw</li> <li>Chain Sharpening Machine</li> </ul> <p><b>Engines and Water Pumps</b></p> <ul style="list-style-type: none"> <li>Engine –Diesel-(Horizontal)</li> <li>Engine –Diesel(Vertical)</li> <li>Engine-Kerosene</li> <li>Water Pump with Petrol Engine</li> <li>Water Pump with Kerosene Engine</li> <li>Water Pump with Diesel Engine</li> </ul> <p><b>Hand Tools</b></p> <ul style="list-style-type: none"> <li>Secateurs</li> <li>Folding Saw</li> <li>Garden Rake</li> <li>Garden Shovel</li> <li>Hedge Shear</li> <li>Lopper</li> <li>Telescopic Hedge Shear</li> <li>Telescopic Lopping Shear</li> <li>Tree Pruner</li> <li>Telescopic Steel Pipe &amp; Fruit Picker Bag</li> <li>Sheep Shear</li> </ul> <p><b>Garden Tools</b></p> <ul style="list-style-type: none"> <li>Electric Pressure Washer</li> <li>Hedge Trimmer</li> <li>Lawn Mower (Electric, Petrol &amp; Manual)</li> <li>Leaf Blower</li> </ul> | <p><b>Cultivators and Accessories</b></p> <ul style="list-style-type: none"> <li>Petrol and Diesel</li> </ul> <p><b>Sprayers and Accessories</b></p> <ul style="list-style-type: none"> <li>Battery Sprayer</li> <li>Portable Power Sprayer</li> <li>Trolley Sprayer</li> <li>Manual Knapsack Sprayer</li> <li>Manual Pressure Sprayer</li> <li>Rose Cans</li> <li>Hose Crimping Machine</li> <li>HTP Sprayer</li> <li>HTP Delivery Hose</li> <li>HTP Hose Reel</li> <li>HTP Stand</li> <li>HTP Gun / Lance(Brass Rod)</li> <li>Knapsack Power Sprayer</li> <li>Mister / Duster / Granuel Spreader</li> <li>HTP Sprayer Set with Diesel Engine</li> <li>HTP Sprayer Set with Kerosene Engine</li> <li>Fogging Machine</li> </ul> <p><b>Milking Machine</b></p> <ul style="list-style-type: none"> <li>Wood Shredder</li> <li>Fodder Ensiling Chaff Cutter</li> <li>Fodder Grinder Chaff Cutter</li> <li>Fodder Mini Chaff Cutter</li> </ul> <p><b>Harvester</b></p> <ul style="list-style-type: none"> <li>Maize Sheller</li> <li>Maize Sheller + Dehusker</li> <li>Maize Combine Harvester</li> <li>Onion Digger Carlotti Italy</li> <li>Tea Leaf Harvester</li> <li>Sugarcane Combine Harvester</li> <li>Sugarcane Leaf Stripper</li> </ul> <p><b>Transplanter and Post Hole Digger</b></p> <ul style="list-style-type: none"> <li>Paddy Transplanter (2 &amp; 8 Rows)</li> <li>Transplanter-Vegetable &amp; Tobacco</li> <li>Post Hole Digger(4" to 14" Augers)</li> </ul> |
|--|---|

to, loss of use, loss of profits, loss of production, expense of substitute equipment or other commercial loss or damage.

**Limitation of Liability:** This limited warranty is in lieu of all other express warranties, obligations, or liabilities. Any implied warranties, obligations or liabilities, including, but not limited to, any implied warranty of merchantability shall be limited in duration to the applicable warranty period. Any action for breach of any warranties hereunder, including, but not limited to, any implied warranty of merchantability must be brought within the applicable warranty period.

**Modifications of Warranty:** No agent, representative, dealer, or employee of KisanKraft Limited or any of its manufacturers has the authority to increase or alter the obligations of this warranty.

**Assignment / Transfer of warranty:** The warranty cannot be assigned and shall not transfer if the product is resold by the first buyer. The above warranties are extended to the first end user (original purchaser), and no warranty is made, nor authorized to be made assignable on resale by the first end user.

**What you must do to obtain limited warranty service:** To obtain performance of any obligation under this warranty for failure during the applicable warranty period, you must deliver the defective product, to the nearest Authorized Dealer, along with proof-of-purchase (invoice/receipt). KisanKraft Limited, its manufacturers and its dealers reserve the right to inspect the claimed defective part(s) to determine if the malfunction is the result of a defect covered by this warranty. Please note that the decision of KisanKraft Limited with respect to any warranty claim is final.

**After-sales Service (Including Warranty):** KisanKraft Limited does not sell directly to consumers. All sales or supplies are made through Authorized Dealers. It is the responsibility of the Authorized Dealer to provide all after-sales service to consumers. Any warranty claim should be raised by dealer to KisanKraft Limited as per warranty policy.

**Jurisdiction:** All disputes are subject to Bangalore court's jurisdiction.

**Notes:**

- This purchase is not contingent upon a product demonstration. The purchaser shall satisfy himself with the product, including any product demonstration or verification of any function, before buying. KisanKraft Limited or its authorized dealers, including online sellers, shall not be liable to give any on-site demonstration after purchase of any of the product.
- Any product once used will not be taken back by KisanKraft Limited.
- Warranty and After Sale Services (including but not limited to installation, Demonstration, Repair, Routine Maintenance etc.), should be done through the Authorized Dealer selling this product.
- Dealers should have their own technician to provide After Sales Services to their Customers. KisanKraft Limited provides free training to Authorized Dealer's technicians at KisanKraft Limited's head office, on request from Authorized Dealer

## User Manual



## KisanKraft Limited

Sri Huchhanna Tower, #4, 1<sup>st</sup> Main, 7-A Cross, Maruthi Layout, Dasarahalli,  
HAF Post, Hebbal, Bangalore 560024, Karnataka, INDIA

- ◆ Bangalore (HO) ◆ Ahmedabad ◆ Bhopal ◆ Bhubaneswar ◆ Coimbatore ◆  
◆ Guwahati ◆ Hubli ◆ Hyderabad ◆ Jammu ◆ Jaipur ◆  
◆ Karnal ◆ Kolkata ◆ Lucknow ◆ Pune ◆ Raipur ◆

**CONTENTS**

Before Getting Started ..... 7  
 Symbols on the Machine..... 7  
 Warning Labels on the Machine ..... 7  
 Safety Instructions ..... 9  
 Application ..... 14  
 Parts Description ..... 14  
 Assembly ..... 15  
 Fuel Handling ..... 18  
 Operation ..... 19  
 Maintenance ..... 23  
 Storage ..... 26  
 Transportation ..... 26  
 Troubleshooting ..... 26  
 Technical Specifications ..... 28

|  |  |  |  |
|--|--|--|--|
| Product                                    | <b>Shoulder Mounted Baffle Type Reaper</b> | KisanKraft Invoice Date  |  |
| Brand                                      | <b>KisanKraft</b>                          | KisanKraft Invoice No.   |  |
| Model                                      | <b>KK-SBC-4502, KK-SBC-3804</b>            |  |  |
| <b>WARRANTY PERIOD</b>                     | <b>6 MONTHS</b>                            | FOR THE SPECIFIED PERIOD FROM THE DATE OF SALE OR DELIVERY WHICHEVER IS EARLIER. |  |
| Dealer's Invoice Date                      |  | Dealer's Invoice No.   |  |
| Buyer's Info (Name, Address, Phone, etc.): |  | Dealer's Stamp (Address, Phone, TIN, etc.):                                      |  |
| Buyer's Sign                               |  | Dealer's Sign  |  |

**Warranty Policy**

**What is covered:** KisanKraft Limited and its manufacturers warrant this product to be free from defects in material or workmanship. All parts defective in material and workmanship are covered. This warranty will only cover defects arising under normal usage. This warranty is limited to repair or replacement by KisanKraft Limited or its manufacturers of such parts as appear to KisanKraft or its manufacturers, upon inspection, to be defective in material and/or workmanship. KisanKraft or its manufacturers make no warranty with respect to items not manufactured or sold by them. No onsite warranty is provided by KisanKraft Limited or its manufacturers. Defective items must be brought/sent to our Authorized Dealer or KisanKraft Limited's office for service.

**What is not covered:** The *warranty shall become null and void* and neither KisanKraft Limited nor any of its manufacturers, nor its authorized dealers assumes any responsibility, if the failure was caused by the following:

- (1) Operation of product with incorrect fuel or lubricants, (2) Incorrect usage of machine or misuse, (3) Lack of maintenance, (4) Negligence, (5) Accident or physical damage, (6) Repairs made by unauthorized parties and/or with unauthorized parts, (7) Improper set up, adjustments, tampering or altered products (8) Any modification to the product what-so-ever.

**Important:** (1) Normal maintenance and adjustments to the product is the responsibility of the customer. (2) Normal wear and tear are not covered under warranty. (3) Rubber/plastic parts and consumables such as blades, clutch and clutch-bell, sparkplugs, nylon line, air-filters, fuel-filters, oil seals and gaskets etc. are not covered under the warranty. (4) Electrical Motor, Electrical Parts, Battery Etc. are not covered under the warranty.

**Incidental / Consequential Loss:** KisanKraft Limited or its manufacturers will not be liable for general damages, including bodily injuries, or for incidental or consequential damages including, but not limited

**Technical Specifications**

| Model                | KK-SBC- 4502                  | KK-SBC-3804                   |
|----------------------|-------------------------------|-------------------------------|
| Engine type          | 2-stroke                      | 4-stroke                      |
| Equipment mobility   | Shoulder Mounted              | Shoulder Mounted              |
| Maximum engine power | 1.45 kW (1.94 HP)             | 1.0kW (1.34 HP)               |
| Engine displacement  | 51.7 cc                       | 37.7 cc                       |
| Fuel Mixture         | Free Petrol-Oil Mixing Bottle | Free Petrol-Oil Mixing Bottle |
| Net Weight           | 11.0 KGS                      | 11.0 KGS                      |
| Gross Weight         | 12.65 KGS                     | 12.7.7KGS                     |
| 3-point blade        | 25.4 cm(10 inches)            | 25.4 cm(10 inches)            |
| Tap & Go             | Nylon Trimmer head            | Nylon Trimmer head            |
| Accessory            | Free 3-Point Blade            | Free 3-Point Blade            |
|                      | Free Shoulder Belt            | Free Shoulder Belt            |
|                      | Free Tool Kit                 | Free Tool Kit                 |
|                      | Free Paddy Guard              | Free Paddy Guard              |
|                      | Free 10x60T TCT Blade         | Free 10x60T TCT Blade         |
|                      | Free Tap & Go                 | Free Tap & Go                 |

**Note:** Technical data is subject to change without prior notice.

|  |  |  |  |
|--|--|--|--|
| Product                                    | <b>Shoulder Mounted Baffle Type Reaper</b> | KisanKraft Invoice Date  |  |
| Brand                                      | <b>KisanKraft</b>                          | KisanKraft Invoice No.   |  |
| Model                                      | <b>KK-SBC-4502, KK-SBC-3804</b>            |  |  |
| <b>WARRANTY PERIOD</b>                     | <b>6-MONTHS</b>                            | FOR THE SPECIFIED PERIOD FROM THE DATE OF SALE OR DELIVERY WHICHEVER IS EARLIER. |  |
| Dealer's Invoice Date                      |  | Dealer's Invoice No.   |  |
| Buyer's Info (Name, Address, Phone, etc.): |  | Dealer's Stamp (Address, Phone, TIN, etc.):                                      |  |
| Buyer's Sign                               |  | Dealer's Sign  |  |

**Warranty Policy**

**What is covered:** KisanKraft Limited and its manufacturers warrant this product to be free from defects in material or workmanship. All parts defective in material and workmanship are covered. This warranty will only cover defects arising under normal usage. This warranty is limited to repair or replacement by KisanKraft Limited or its manufacturers of such parts as appear to KisanKraft or its manufacturers, upon inspection, to be defective in material and/or workmanship. KisanKraft or its manufacturers make no warranty with respect to items not manufactured or sold by them. No onsite warranty is provided by KisanKraft Limited or its manufacturers. Defective items must be brought/sent to our Authorized Dealer or KisanKraft Limited's office for service.

**What is not covered:** The *warranty shall become null and void* and neither KisanKraft Limited nor any of its manufacturers, nor its authorized dealers assumes any responsibility, if the failure was caused by the following:

- (1) Operation of product with incorrect fuel or lubricants, (2) Incorrect usage of machine or misuse, (3) Lack of maintenance, (4) Negligence, (5) Accident or physical damage, (6) Repairs made by unauthorized parties and/or with unauthorized parts, (7) Improper set up, adjustments, tampering or altered products (8) Any modification to the product what-so-ever.

**Important:** (1) Normal maintenance and adjustments to the product is the responsibility of the customer. (2) Normal wear and tear are not covered under warranty. (3) Rubber/plastic parts and consumables such as blades, clutch and clutch-bell, sparkplugs, nylon line, air-filters, fuel-filters, oil seals and gaskets etc. are not covered under the warranty. (4) Electrical Motor, Electrical Parts, Battery Etc. are not covered under the warranty.

**Incidental / Consequential Loss:** KisanKraft Limited or its manufacturers will not be liable for general damages, including bodily injuries, or for incidental or consequential damages including,

but not limited to, loss of use, loss of profits, loss of production, expense of substitute equipment or other commercial loss or damage.

**Limitation of Liability:** This limited warranty is in lieu of all other express warranties, obligations, or liabilities. Any implied warranties, obligations or liabilities, including, but not limited to, any implied warranty of merchantability shall be limited in duration to the applicable warranty period. Any action for breach of any warranties hereunder, including, but not limited to, any implied warranty of merchantability must be brought within the applicable warranty period.

**Modifications of Warranty:** No agent, representative, dealer, or employee of KisanKraft Limited or any of its manufacturers has the authority to increase or alter the obligations of this warranty.

**Assignment / Transfer of warranty:** The warranty cannot be assigned and shall not transfer if the product is resold by the first buyer. The above warranties are extended to the first end user (original purchaser), and no warranty is made, nor authorized to be made assignable on resale by the first end user.

**What you must do to obtain limited warranty service:** To obtain performance of any obligation under this warranty for failure during the applicable warranty period, you must deliver the defective product, to the nearest Authorized Dealer, along with proof-of-purchase (invoice/receipt). KisanKraft Limited, its manufacturers and its dealers reserve the right to inspect the claimed defective part(s) to determine if the malfunction is the result of a defect covered by this warranty. Please note that the decision of KisanKraft Limited with respect to any warranty claim is final.

**After-sales Service (Including Warranty):** KisanKraft Limited does not sell directly to consumers. All sales or supplies are made through Authorized Dealers. It is the responsibility of the Authorized Dealer to provide all after-sales service to consumers. Any warranty claim should be raised by dealer to KisanKraft Limited as per warranty policy.

**Jurisdiction:** All disputes are subject to Bangalore court's jurisdiction.

**Notes:**

- This purchase is not contingent upon a product demonstration. The purchaser shall satisfy himself with the product, including any product demonstration or verification of any function, before buying. KisanKraft Limited or its authorized dealers, including online sellers, shall not be liable to give any on-site demonstration after purchase of any of the product.
- Any product once used will not be taken back by KisanKraft Limited.
- Warranty and After Sale Services (including but not limited to installation, Demonstration, Repair, Routine Maintenance etc.), should be done through the Authorized Dealer selling this product.
- Dealers should have their own technician to provide After Sales Services to their Customers. KisanKraft Limited provides free training to Authorized Dealer's technicians at KisanKraft Limited's head office, on request from Authorized Dealer.

| Check                   | Probable cause    | Action to be taken |
|-------------------------|-------------------|--------------------|
| Air cleaner             | Clogged with dust | Wash               |
| Cylinder fin, fan cover | Clogged with dust | Clean              |

When your unit seems to need further service, please contact your dealer or company service center

### Storage

Aged fuel is one of major causes of engine starting failure. Before storing the unit, empty the fuel tank and run the engine until it uses all the fuel left in the fuel line and the carburetor. Store the unit indoor taking necessary measures for rust prevention.

### Transportation

1. When hand-carrying the product, cover over the cutting part if necessary, lift up the product and carry it paying attention to the blade.
2. Never transport the product over rough roads over long distances by vehicle without removing all fuel from the fuel tank. If doing so, fuel might leak from the tank during transport.

### Troubleshooting

#### Case 1. Starting failure

| Check                       | Probable cause           | Action to be taken             |
|-----------------------------|--------------------------|--------------------------------|
| Fuel tank                   | Incorrect fuel           | Drain it and with correct fuel |
| Fuel filter                 | Fuel filter is clogged   | Clean the fuel filter          |
| Carburetor adjustment screw | Out of normal range      | Adjust to normal range         |
| Sparking (no spark)         | Spark plug is fouled/wet | Clean/dry the spark plug       |
|                             | Plug gap is incorrect    | Correct (GAP: 0.6–0.7mm)       |
| Spark plug                  | Disconnected             | Retighten the spark plug       |

#### Case 2. Engine starts but does not keep running/Hard re-starting:

| Check                            | Probable cause                | Action to be taken             |
|----------------------------------|-------------------------------|--------------------------------|
| Fuel tank                        | Incorrect fuel or staled fuel | Drain it and with correct fuel |
| Carburetor adjustment screw      | Out of normal range           | Adjust to normal range         |
| Muffler, cylinder (exhaust port) | Carbon is built-up            | Wipe away                      |

### Before Getting Started

Before using the machine for the first time be sure to read through this manual in order to avoid wrong operation. Please preserve this manual properly so that it can provide you with information whenever necessary.

### Symbols on the Machine

For safe operation and maintenance, symbols are carved in relief on the machine. According to these indications, please be careful not to make a mistake.

### Warning Labels on the Machine



Warning / Attention



Danger: Risk of fire or explosion



Read the instruction manual completely and carefully before using the tool.



Top speed of trimmer head is 6600 min<sup>-1</sup>



Wear head, eye and ear protection.



Top speed of blade is 7100 min<sup>-1</sup>



Wear protective gloves.



The port to refuel the "MIX FUEL"



Wear safety footwear



The guaranteed noise level



Danger: Tougthing the rotating blade is forbidden.



With this symbol the manufacturer confirms that this tool is in accordance with applicable European directives.



Beware of thrown objects.



Hot surface: Risk of burn.



Keep away from fire



Keep all children, bystanders and helpers 15 meters away from the brush cutter

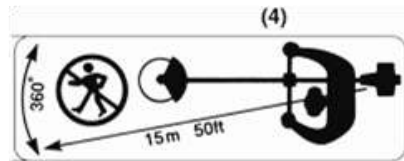

Never modify your BrushCutter. We won't warrant the machine, if you use the remodeled BrushCutter or you don't observe the proper usage written in the manual

**CHOKE OPERATION**



Starting mode when the engine is hot (choke off).  
Position: AIR CLEANER COVER



Starting mode when the engine is cold (choke on).  
Position: AIR CLEANER COVER

**IMPORTANT**

If warning label peel off or become soiled and impossible to read, you should contact the dealer from whom you purchased the product to order new labels and affix them in the required location(s).

**WARNING**

Never modify your brush cutter. We won't warrant the machine, if you use the remodeled brush cutter or you don't observe the proper usage written in the manual.

**Spark Plug:**

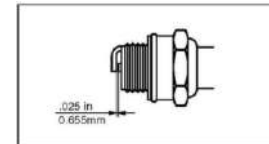

- Starting failure and misfiring are often caused by a fouled spark plug. Clean the spark plug and check that the plug gap is in the correct range. For a replacement plug, use the correct type
- Periodically clean the spark plug and check that the spark gap is in the correct range.

**IMPORTANT**

Note that using any spark plugs other than those designated may result in the engine failing to operate properly or in the engine becoming overheated and damaged.

- To install the spark plug, first turn the plug until it is finger tight, then tighten it a quarter turn more with a socket wrench.

TIGHTENING TORQUE: 9.8~11.8 N.m

**Muffler:**

**WARNING**

- Inspect periodically, the muffler for loose fasteners, any damage or corrosion. If any sign of exhaust leakage is found, do not use the brush cutter and have it repaired immediately.
- Note that failing to do so may result in the engine catching on fire.

**Intake Air Cooling Vent:**

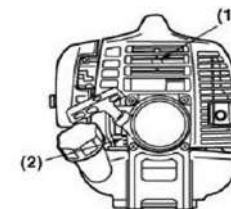

- (1) Cylinder fin
- (2) Intake air cooling vent (back)

**WARNING**

Check the intake air cooling vent and the area around the cylinder cooling fins after every 25 hours of use for blockage, and remove any waste which has attached itself to the brush cutter.

**IMPORTANT**

If waste gets stuck and causes blockage around the intake air cooling vent or between the cylinder fins, it may cause the engine to overheat, and that in turn may cause mechanical failure on the part of the brush cutter



**Refilling Trimming Line:**

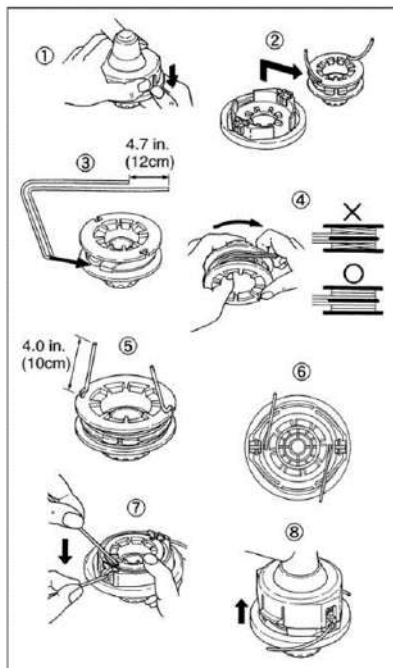

1. For replacement line, use a diameter of 2.4mm (.095in). The spool is capable for a line up to 6m (20ft) on the 10cm (4") head. Avoid using a larger line as it may cut down the trimming performance.
2. Pinch the slotted area on the both sides of the spool housing to unhook the bottom cap.
3. Take out the spool and pull off the old line. Put one end of new line through the spool holes and pull it until the length is equal between each part of the line.
4. Wind up the line in the correct direction as indicated on the spool.
5. Hook each end of the line in the slot on the edge of the spool, and then put the ends through the eyelets on the housing. Make sure that the spring and the washers are in place.
6. While holding the spool against the housing, pull the line ends to release them from the slot.
7. Line up the slot on the bottom cap with the hook on the housing, press the cap against the housing until it clicks.

**Air Filter:**

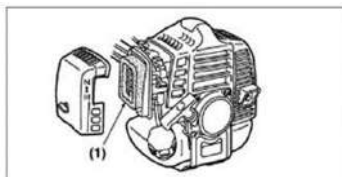

The air filter, if clogged, will reduce the engine performance. Monthly check and clean the filter element in warm, soapy water as required. Dry completely before installing. If the element is broken or shrunk, replace with a new one.

Note: In the adjacent fig:  
(1) Air Filter

**Fuel Filter:**

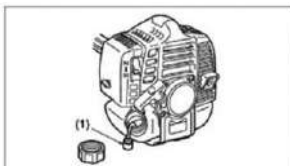

When the engine runs short of fuel supply, check the fuel cap and the fuel filter for blockage.

Note: In the adjacent fig:  
(1) Fuel Filter

**Safety Instructions**



**Working Condition**

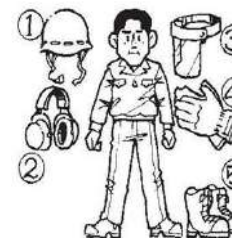

1. Read this manual carefully until you completely understand and follow all safety and operating instructions.
  2. Keep this manual handy so that you may refer to it later whenever any questions arise. Also note, if you have any questions which cannot be answered herein, contact the dealer from whom you purchased the product.
  3. Always be sure to include this manual when selling, lending, or otherwise transferring the ownership of this product.
  4. Never allow children or anyone unable to fully understand the directions given in the manual to use the machine.
1. When using the product, you should wear proper clothing and protective equipment.
    - (1) Helmet
    - (2) Ear protectors
    - (3) Protection goggles or face protector
    - (4) Thick work gloves
    - (5) Non-slip-sole work boots
  2. And you should carry with you.
    - (1) Attached tools and files
    - (2) Properly reserved fuel
    - (3) Spare blade
    - (4) Things to notify your working area (rope, warning signs)
    - (5) Whistle (for collaboration or emergency)
    - (6) Hatchet or saw (for removal of obstacles)
  3. Do not wear loose clothing, jewelry, short trousers, sandals, or go barefoot. Do not wear anything which might be caught by a moving part of the unit. Secure hair so it is above shoulder length.

**Working Circumstance**

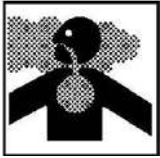

1. Never start the engine inside a closed room or building. Exhaust gases contain dangerous carbon monoxide.
2. Never use the product,
  - a) When the ground is slippery or when you can't maintain a steady posture.
  - b) At night, at times of heavy fog, or at any other times when your field of vision might be limited and it would be difficult to gain a clear view of the working area.
  - c) During rain storms, during lightning storms, at times of strong or gale-force winds, or at any other times when weather conditions might make it unsafe to use the product.



**Working Plan**



1. You should never use the product when under the influence of alcohol, when suffering from exhaustion or lack of sleep, when suffering from drowsiness as a result of having taken cold medicine or at any other time when a possibility exists that your judgment might be impaired or that you might not be able to operate the product properly and in a safe manner.
2. When planning your work schedule, allow plenty of time to rest. Limit the amount of time over which the product is to be used continuously to somewhere around 30~40 minutes per session, and take 10~20 minutes of rest between work sessions. Also try to keep the total amount of work performed in a single day under 2 hours or less.



**WARNING**



1. If you don't observe the working time, or working manner, Repetitive Stress Injury (RSI) could occur. If you feel discomfort, redness and swelling of your fingers or any other part of your body, see a doctor before getting worse.
2. To avoid noise complaints, in general, operate product between 8a.m. and 5p.m. on weekdays and 9a.m. to 5p.m. during Weekends.

**NOTE:**

Check and follow the local regulations as to sound level and hours of operations for the product.

**Cutting Method:**

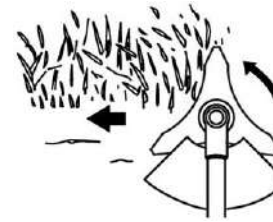

1. Use the front left side cutting.
2. Guide the blade from your right to left with it tilted slightly to your left.
3. When mowing a wide area, start working from your left end to avoid interference of cut grass.
4. The blade may be seized by weeds if the engine speed is too low, or the blade cuts too deep into weeds. Adjust the engine speed and cutting depth according to the condition of object.

**WARNING**

- If the grass or other object gets caught in the blade, or if the unit starts to shake or vibrate, turn off the engine and check the whole unit. Change the blade if it has been damaged.
- Turn off the engine and make sure the blade has completely stopped before checking the blade, and removing any object got caught in.

**Maintenance**

**WARNING**

- Always be sure to stop the engine before inspecting the brush cutter for problems or performing maintenance.
- Never alter the brush cutter or take the engine apart.

|        | System/components                  | Procedure                    | Before use | Every 25 hours after | Every 50 hours after | Every 100 hours after | Note   |
|--------|------------------------------------|------------------------------|------------|----------------------|----------------------|-----------------------|--|
| ENGINE | fuel leaks, fuel spillage          | wipe out                     | ✓          |                      |                      |                       |  |
|        | fuel tank, air filter, fuel filter | inspect/clean                | ✓          | ✓                    |                      |                       | replace, if necessary                                |
|        | idle speed adjuster                | see adjusting idling speed   | ✓          |                      |                      |                       | replace carburetor if necessary                      |
|        | spark plug                         | clean and readjust plug gap  |            |                      | ✓                    |                       | GAP: .025 in (0.6 ~ 0.7 mm)<br>replace, if necessary |
|        | intake air cooling vent            | clean                        |            | ✓                    |                      |                       |  |
| SHAFT  | throttle trigger, stop switch      | check operation              | ✓          |                      |                      |                       |  |
|        | cutting parts                      | replace if something's wrong | ✓          |                      |                      |                       |  |
|        | angle transmission                 | grease                       |            | ✓                    |                      |                       |  |
|        | screws/nuts/bolts                  | tighten/replace              | ✓          |                      |                      | ✓                     | except adjusting screws                              |
|        | cutting attachment guard           | make sure to attach          | ✓          |                      |                      |                       |  |

**Adjusting the Line Length:**

- Your brush cutters is equipped with a semiauto type nylon line head that allows the operator to advance the line without stopping the engine. When the line becomes short, lightly tap the head on the ground while running the engine at full throttle.
- Each time the head is bumped, the line advance about 1 inch (25.4 mm). For better effect, tap the head on bear ground or hard soil. Avoid bumping in thick, tall grass as the engine may stall by overload.

**Metal Blade Usage:**



**NOTE:**

Choose a suitable recommended cutting attachment according to the object to be cut.

**WARNING**

When sharpening, removing, or reattaching the blade, be sure to wear thick, sturdy gloves and use only proper tools and equipment to prevent injury.

1. Check the bolt to fasten the blade and be sure the bolt has no fault, and no abrasion.
2. Be sure that the blade and the holder have been fastened according to instruction and the blade turns smoothly without abnormal noise.

**WARNING**

- The rotating parts fastened incorrectly may cause serious accident to the operator.
- Make sure that the blade is not bent, warped, cracked, broken or damaged.
- If you find any error to the blade, discard it and change new one.
- By using the harness, hang the unit on your right side. Adjust the harness length so that the cutting head may become parallel to the ground

**Before Starting the Engine**



1. The area within a perimeter of 50 feet (15m) of the person using the product should be considered a hazardous area into which no one should enter. If necessary, yellow warning rope, warning signs should be placed around the perimeter of the area. When work is to be performed simultaneously by two or more persons, care should also be taken to constantly look around or otherwise check for the presence and locations of other people working so as to maintain a distance between each person sufficient to ensure safety.
  2. Check the condition of working area to avoid any accident by hitting hidden obstacles such as stumps, stones, cans, or broken grass.
- IMPORTANT**
3. Remove any obstacle before beginning work.
  3. Inspect the entire unit for loose fasteners and fuel leakage. Make sure that the cutting attachment is properly installed and securely fastened.
  4. Be sure the debris guard is firmly attached in place.
  5. If the cutting head is the metal blade, use the shoulder strap. Adjust the strap for comfort before starting the engine. The strap should be adjusted so the left hand can comfortably hold the handlebar grip approximately waist high

### Starting the Engine



1. Keep bystanders and animals at least 50feet (15m) away from the operating point. If you are approached, immediately stop the engine.
2. The product is equipped with a centrifugal clutch mechanism, so the cutting attachment begins to rotate as soon as the engine is started by putting the throttle into the start position. When starting the engine, place the product onto the ground in a flat clear area and hold it firmly in place so as to ensure that neither the cutting part nor the throttle come into contact with any obstacle when the engine start.

**⚠️ WARNING:** Never place the throttle into the high speed position when starting the engine.

3. After starting the engine, check to make sure that the cutting attachment stops rotating when the throttle is moved fully back to its original position. If it continues to rotate even after the throttle has been moved fully back, turn off the engine and take the unit to your authorized servicing dealer for repair.

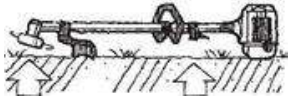

### Using the Product

#### ⚠️ IMPORTANT

Cut only materials recommended by the manufacturer. And use only for tasks explained in the manual.



1. Grip the handles firmly with both hands using your whole hand. Place your feet slightly apart (slightly further apart than the width of your shoulders) so that your weight is distributed evenly across both legs, and always be sure to maintain a steady, even posture while working.
2. Keep cutting attachment below waist level.
3. Maintain the speed of the engine at the level required to perform cutting work, and never raise the speed of the engine above the level necessary.
4. If the unit start to shake or vibrate, turn off the engine and check the whole unit. Do not use it until the trouble has been properly corrected.
5. Keep all parts of your body away from rotating cutting attachment and hot surfaces.



### Adjusting Idling Speed:

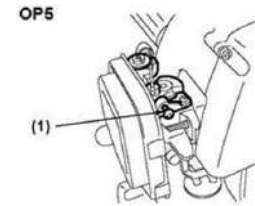

1. When the engine tends stop frequently at idling mode, turn the adjusting screw clockwise.
2. When the cutting head keeps rotating after releasing the trigger, turn the adjusting screw.

#### 📖 NOTE:

Warm up the engine before adjusting the idling speed.

### Trimmer Head Usage:

#### ⚠️ WARNING

1. Always wear eye protection such as safety goggles. Never lean over the rotating cutting head. Rocks or other debris could be thrown into eyes and face and cause serious personal injury.
2. Keep the debris guard attached in place at all times when the unit is operated.

### Trimming Grass and Weeds:

Always remember that the TIP of the line does cutting. You will achieve better results by not crowding the line into the cutting area. Allow the unit to trim at its own pace.

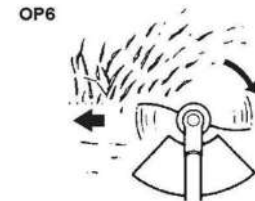

1. Hold the unit so the head is off the ground and is tilted about 20 degrees toward the sweep direction. (OP6)
2. You can avoid thrown debris by sweeping from your right to the left.
3. Use a slow, deliberate action to cut heavy growth. The rate of cutting motion will depend on the material being cut. Heavy growth will require slower action than will light growth.
4. Never swing the unit as hard as you are in danger of losing your balance or control of the unit.
5. Try to control the cutting motion with the hip rather than placing the full workload on the arm and hands.
6. Take precautions to avoid wire, grass and dead, dry, long-stem weeds from wrapping around the head shaft. Such materials can stall the head and cause the clutch to slip, resulting in damage to the clutch system if repeated frequently.



3. Push the primer pump several times until overflow fuel flows out in the return tube.

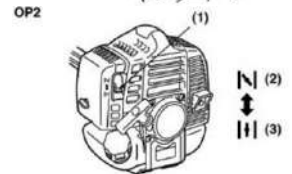

4. Move the choke lever to the closed position.

Note: In the adjacent figure,  
**(1)** Choke lever  
**(2)** Closed position  
**(3)** Open position



5. Set the ignition switch to the "start" position. While pulling the throttle lever, push the throttle set button, and release the throttle, then the throttle lever is into the "Start" position.

Note: In the adjacent figure,  
**(A)** Stop position  
**(B)** Start position



6. While holding the unit firmly, pull out the starter rope quickly until engine fires.

**IMPORTANT**

Avoid pulling the rope to its end or returning it by releasing the knob. Such actions can cause starter failures.

7. Move the choke lever to the open position (OP2). And pull out the starter rope quickly to restart engine. (OP4)
8. Allow the engine to warm up for several minutes before starting operation.

**NOTE**

1. When restarting the engine immediately after stopping it, leave the choke open (OP2) and push the primer pump several times (OP4).
2. Over chocking can make the engine hard to start due to excess fuel. When the engine failed to start after several attempts, open the choke and repeat pulling the rope, or remove the spark plug and dry it.

**Stopping the Engine:**

1. Release the throttle lever and run the engine for a half minute.
2. Shift the ignition switch to the STOP position. (OP3)

**NOTE**

Except for an emergency, avoid stopping the engine while pulling the throttle lever.



6. Never touch the muffler, spark plug, or other metallic parts of the engine while the engine is in operation or immediately after shutting down the engine. Doing so could result in serious burns or electrical shock.

**If Someone Comes**



1. Guard against hazardous situations at all times. Warn adults to keep pets and children away from the area. Be careful if you are approached. Injury may result from flying debris.
2. If someone calls out or otherwise interrupts you while working, always be sure to turn off the engine before turning around

**Maintenance**



1. In order to maintain your product in proper working order, perform the maintenance and checking operations described in the manual at regular intervals.
2. Always be sure to turn off the engine before performing any maintenance or checking procedures.

**WARNING**

The metallic parts reach high temperatures immediately after stopping the engine.

3. Under no circumstances should you ever take apart the product or alter it in any way. Doing so might result in the product becoming damaged during operation or the product becoming unable to operate properly

**Handling Fuel**



1. The engine of the product is designed to run on a mixed fuel which contains highly flammable petrol. Never store cans of fuel or refill the tank of the unit in any place where there is a boiler, stove, wood fire, electrical sparks, welding sparks, or any other source of heat or fire which might ignite the fuel.
2. Never smoke while operating the unit or refilling its fuel tank.
3. When refilling the tank, always turn off the engine and allow it to cool down. Take a careful look around to make sure that there are no sparks or open flames anywhere nearby before refueling.
4. Wipe spilled fuel completely using a dry rag if any fuel spillage occurs during refueling.
5. After refueling, screw the fuel cap back tightly onto the fuel tank and then carry the unit to a spot 10feet (3m) or more away from where it was refueled before turning on the engine.

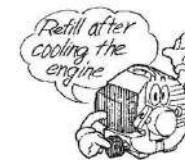

**Transportation**



1. When hand-carrying the product, cover over the cutting part if necessary, lift up the product and carry it paying attention to the blade.
2. Never transport the product over rough roads over long distances by vehicle without removing all fuel from the fuel tank. If doing so, fuel might leak from the tank during transport.

**Application**

If the Brush cutter is fitted with **cutting string** as trimmer as attachment, it is used for **cutting grass** grown in **park, garden** and **around tree** or **fence**.

If the Brush cutter uses **metal cutting blade** as attachment, used for **cutting grass, weed** or **light plant**.

When Brush cutter uses **metal (TCT) cutting blade** with **paddy guard** as attachment, used for harvesting **paddy, wheat** and other **cereal crops**.

**Note:** Any other purpose not specified and permitted in this manual may damage device and cause serious injury to the user. Do not use this device to cut thorn, shrub or bush. The manufacturer shall not be responsible for damage caused by wrong operation.

**Parts Description**

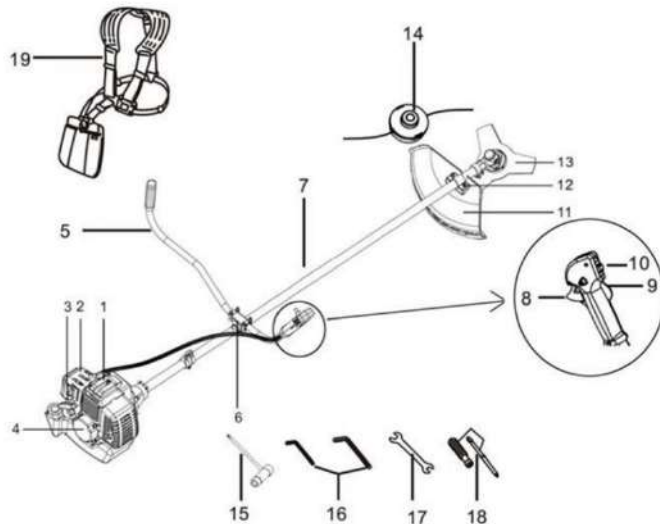

- Mixed fuels which have been left unused for a period of one month or more may clog the carburetor or result in the engine failing to operate properly. Put remained fuel into an air-tight container and keep it in the dark and cool room.
- Please ask for “mixed petrol for air-cooled 2-cycle engines” at your nearest gas station, or use fuel made by putting unleaded petrol for automobiles and air-cooled 2-cycle engine oil into a mixing container in accordance with the following ratios and then shaking to mix well.

**HOW TO MIX FUEL:**



1. Measure out the quantities of petrol and oil to be mixed.
2. Put some of the petrol into the clean, approved fuel container supplied.
3. Pour in the oil and agitate well.
4. Be careful that, if the agitation is insufficient, there is an increased danger of early piston seizing due to abnormally lean mixture.

**Mixing ratios:**

When using commercially available 2-cycle oil: **25:1**  
**(40 ml of oil for every 1 liter of petrol)**

**FUELING THE UNIT:**

1. Untwist and remove the fuel cap. Rest the cap on a dustless place.
2. Pour fuel into the fuel tank to 80% of the full capacity.
3. Fasten the fuel cap securely and wipe up any fuel spillage around the unit.
4. Fill 60-80 ml oil into the oil tank. (in case of 4-stroke engine)

**WARNING**

1. Select bare ground for fueling.
2. Move at least 10ft (3m) away from the fueling point before starting the engine.
3. Stop the engine before refueling the unit.
4. In the case of storing the product for a long period of time, clean the fuel tank after rendering it empty. Next, activate the engine and empty the carburetor of the composite fuel.

**Operation**

**Starting the Engine:**



**The cutting head will start rotating upon the engine starts.**

1. Feed fuel into the fuel tank and tighten the cap securely.
2. Rest the unit on a flat, firm place. Keep the cutting head off the ground and clear of surrounding objects as it will start rotating upon starting of the engine.

**How to Wear:**



1. Wear the provided harness without twisted bands, with the hanger on your right side.  
(1) Hanger

**Balance the Unit:**



1. Hook your machine to the hanger.
2. Adjust the bands of the harness to have the blade parallel to the ground when standing in your normal working position to provide you most effectiveness and comfort on operating the machine.
3. In order to prevent the hanger position to change during operation, turn up the extra part of the band from the buckle.
4. When correctly adjusted, check the correct working of the harnesses' QUICK RELEASE.



**Fuel Handling**

**⚠ WARNING**

- Petrol is very flammable. Avoid smoking or bringing any flame or sparks near fuel.
- Wipe up all spills before starting the engine.
- Make sure to stop the engine and allow it cool before refueling the unit.
- Keep open flames away from the area where fuel is handled or stored.



**! IMPORTANT**

- Never use oil for 4 cycle engine use or water cooled 2-cycle engine.
- Never use "FUEL WITH NO OIL (PURE PETROL)".
- Never use fuel laced with water.

- |                           |                             |
|---------------------------|-----------------------------|
| 1. Engine                 | 11. Protection shield       |
| 2. Air cleaner cover      | 12. Protection shield plate |
| 3. Choke lever            | 13. 3T blade                |
| 4. Recoil starter         | 14. Line Head               |
| 5. Handle                 | 15. Wrench                  |
| 6. Handle bracket         | 16. Angled bar              |
| 7. Pipe                   | 17. Spanner                 |
| 8. Throttle Trigger lever | 18. Wrench                  |
| 9. Throttle lever         | 19. Harness                 |
| 10. Switch                |                             |

**Assembly**

**Installing Handle:**

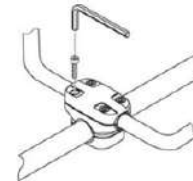

1. Loosen the 4bolts on the upper cap and insert the handles equally. Retighten the bolts.
2. Put the handle assembly into the bracket and put the upper cap over it. Tighten the cap securely.

**Connecting Throttle Wire:**



1. Remove the air cleaner cover.
2. Connect the end of the throttle wire to the joint on the top of the carburetor.

**Connecting Switch Wires:**

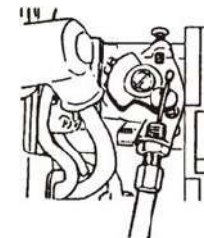

Connect the switch wires between the engine and the main unit.  
Pair the wires of the same color.

**Installing Protection Shield:**

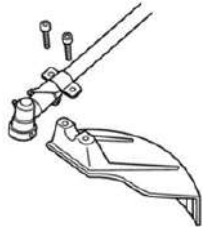

Attach the protection shield with the bolts combined to the shaft tube.

### Installing Cutting Blade:

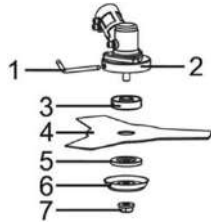

1. Put the angled bar (1) into the side holes of the gear case (2) and the plate (3) so as to fasten the axle.
2. Mount the blade (4) and the washer (5) onto the axle.
3. Mount the washer (6) and the nut (7). Fasten tightly anti-clockwise.

### Installing Cutting Head:

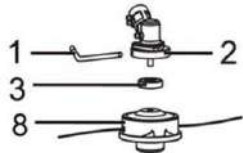

1. Put the angled bar (1) into the side holes of the gear case (2) and the plate (3) so as to fasten the axle.
2. Mount the trimmer head (8) on the axle. Fasten tightly anti-clockwise.

### Note

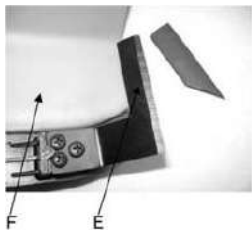

Before using the trimmer head, mount the trimmer knife (E) to protection shield (F) with 3 screws. When the machine is running, tap the trimmer head on the ground, and trimmer line will come out automatically. The trimmer knife will cut and keep the trimmer line in the correct length.

### Connecting Cutting Attachment:

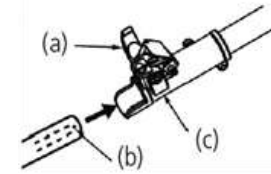

Insert the trimmer cutting attachment (b) into the main drive shaft (c) and tighten the knob (a) on the split connector securely.

### IMPORTANT

Align the cutting attachment into split connector by locking it. When difficult to engage, twist the shaft housing slightly.

### Harness:



### WARNING

- **ALWAYS WEAR THE PROVIDED HARNESS WHEN USING THE MACHINE!**
- Always make sure the machine is hooked securely to the harness. If you don't, you will be unable to control the machine safely. This can result in injury to yourself or others.
- Never use a harness with a defective quick release or any other damage.