

Product	Agricultural Sprayer (Manual) / Agricultural Knapsack Sprayer (Manual)	KisanKraft Invoice Date	
Brand	KisanKraft	KisanKraft Invoice No.	
Model	<input type="checkbox"/> KK-PS1000, KK-TS1000, KK-PS1500, KK-PS2000, <input type="checkbox"/> KK-PS3000, KK-PS5000, KK-PS8000, <input type="checkbox"/> KK-11L, KK-12L, KK-16L <input type="checkbox"/> KK-KMS-8617		
WARRANTY PERIOD	6 MONTHS	FOR THE SPECIFIED PERIOD FROM THE DATE OF SALE OR DELIVERY WHICHEVER IS EARLIER.	
Dealer's Invoice Date		Dealer's Invoice No.	
Buyer's Info (Name, Address, Phone, etc.):		Dealer's Stamp (Address, Phone, TIN, etc.):	
Buyer's Sign		Dealer's Sign	

What is covered: KisanKraft Limited and its manufacturers warrant this product to be free from defects in material or workmanship. All parts defective in material and workmanship are covered.

This warranty will only cover defects arising under normal usage.

This warranty is limited to repair or replacement by KisanKraft Limited or its manufacturers at the premises of Authorized Dealers, of such parts as appear to KisanKraft or its manufacturers, upon inspection, to be defective in material and/or workmanship. KisanKraft or its manufacturers make no warranty with respect to trade accessories not manufactured or sold by them.

What is not covered: The *warranty shall become null and void* and neither KisanKraft Limited nor any of its manufacturers, nor its authorized dealers assumes any responsibility, if the failure was caused by the following: (1) Operation of product with incorrect fuel or lubricants, (2) Incorrect usage of machine or misuse, (3) Lack of maintenance, (4) Negligence, (5) Accident or physical damage, (6) Repairs made by unauthorized parties and/or with unauthorized parts, (7) Improper set up, adjustments, tampering or altered products.

Note: The purchase is not contingent upon a product demonstration. The purchaser shall satisfy himself with the product, including any product demonstration or verification of any function, before buying. KisanKraft Limited or its authorized dealers, including online sellers, shall not be liable to give any on-site demonstration after purchase of any of the product

This warranty is null & void, if you fail to register the warranty with KisanKraft by sending the KisanKraft Copy with dealer's stamp.

KisanKraft Limited (formerly known as KisanKraft Machine Tools P Ltd)

🌐: www.kisankraft.com

✉: info@kisankraft.com

☎: +91.80. 22178200

Important: (1) Normal maintenance and adjustments to the product is the responsibility of the customer. (2) Normal wear and tear is not covered under warranty (3) Rubber/plastic parts and consumables such as blades, clutch and clutch-bell, spark-plugs, nylon line, air-filters, fuel-filters, oil seals etc. are not covered under the warranty.

No Warranty On Electrical Motor / Electrical Parts / Battery Etc.

Incidental / Consequential Loss: KisanKraft Limited or its manufacturers will not be liable for general damages, including bodily injuries, or for incidental or consequential damages including, but not limited to, loss of use, loss of profits, loss of production, expense of substitute equipment or other commercial loss or damage.

Limitation of Liability: This limited warranty is in lieu of all other express warranties, obligations, or liabilities. Any implied warranties, obligations or liabilities, including, but not limited to, any implied warranty of merchantability shall be limited in duration to the applicable warranty period. Any action for breach of any warranties hereunder, including, but not limited to, any implied warranty of merchantability must be brought within the applicable warranty period.

Modifications of Warranty: No agent, representative, dealer, or employee of KisanKraft Limited or any of its manufacturers has the authority to increase or alter the obligations of this warranty.

Assignment / Transfer of warranty: The warranty cannot be assigned and shall not transfer if the product is resold by the first buyer. The above warranties are extended to the first end user (original purchaser), and no warranty is made, nor authorized to be made assignable on resale by the first end user.

What you must do to obtain limited warranty service: To obtain performance of any obligation under this warranty for failure during the applicable warranty period, deliver the defective product, to the nearest Authorized Dealer. KisanKraft Limited, its manufacturers and its dealers reserve the right to inspect the claimed defective part(s) to determine if the malfunction is the result of a defect covered by this warranty. Please note that the decision of KisanKraft Machine Tools Pvt Ltd with respect to any warranty claim is final.

Receipt is required for availing warranty services

Jurisdiction: All disputes are subject to Bangalore court's jurisdiction.

Our Products	◆Chainsaws◆Brush Cutters and Accessories◆Harvesters◆ ◆Engines and Water Pumps◆Hand Tools◆Garden Tools ◆ ◆Cultivators and Accessories◆Sprayers and Accessories◆ ◆Transplanter and Post Hole Digger ◆Milking Machines ◆
---------------------	--

This warranty is null & void, if you fail to register the warranty with KisanKraft by sending the KisanKraft Copy with dealer's stamp.

KisanKraft Limited (formerly known as KisanKraft Machine Tools P Ltd)

KisanKraft®

Agricultural Sprayer (Manual)
KK-PS1000/1500/2000/3000/5000/8000
KK-TS1000, KK-11L
Agricultural Knapsack Sprayer (Manual)
KK-12L / 16L, KK-KMS-8617

User Manual



KisanKraft Limited

(Formerly known as KisanKraft Machine Tools Pvt Ltd)

Sri Huchhanna Tower, #4, 1st Main, 7-A Cross, Maruthi Layout, Dasarahalli,
HAF Post, Hebbal, Bangalore 560024, Karnataka, INDIA

- ◆ Bangalore (HO) ◆ Ahmedabad ◆ Bhopal ◆ Bhubaneswar ◆ Coimbatore ◆
- ◆ Guwahati ◆ Hubli ◆ Hyderabad ◆ Jaipur ◆ Karnal ◆
- ◆ Kolkata ◆ Lucknow ◆ Jammu ◆ Pune ◆ Raipur ◆ Shimla ◆



Agricultural Sprayer (Manual)
KK-PS1000/1500/2000/3000/5000/8000
KK-TS1000, KK-11L
Agricultural Knapsack Sprayer (Manual)
KK-12L / 16L, KK-KMS-8617



Warranty Certificate

(KISANKRAFT COPY)

Important: (1) Normal maintenance and adjustments to the product is the responsibility of the customer. (2) Normal wear and tear is not covered under warranty (3) Rubber/plastic parts and consumables such as blades, clutch and clutch-bell, spark-plugs, nylon line, air-filters, fuel-filters, oil seals etc. are not covered under the warranty.

No Warranty On Electrical Motor / Electrical Parts / Battery Etc.

Incidental / Consequential Loss: KisanKraft Limited or its manufacturers will not be liable for general damages, including bodily injuries, or for incidental or consequential damages including, but not limited to, loss of use, loss of profits, loss of production, expense of substitute equipment or other commercial loss or damage.

Limitation of Liability: This limited warranty is in lieu of all other express warranties, obligations, or liabilities. Any implied warranties, obligations or liabilities, including, but not limited to, any implied warranty of merchantability shall be limited in duration to the applicable warranty period. Any action for breach of any warranties hereunder, including, but not limited to, any implied warranty of merchantability must be brought within the applicable warranty period.

Modifications of Warranty: No agent, representative, dealer, or employee of KisanKraft Limited or any of its manufacturers has the authority to increase or alter the obligations of this warranty.

Assignment / Transfer of warranty: The warranty cannot be assigned and shall not transfer if the product is resold by the first buyer. The above warranties are extended to the first end user (original purchaser), and no warranty is made, nor authorized to be made assignable on resale by the first end user.

What you must do to obtain limited warranty service: To obtain performance of any obligation under this warranty for failure during the applicable warranty period, deliver the defective product, to the nearest Authorized Dealer. KisanKraft Limited, its manufacturers and its dealers reserve the right to inspect the claimed defective part(s) to determine if the malfunction is the result of a defect covered by this warranty. Please note that the decision of KisanKraft Machine Tools Pvt Ltd with respect to any warranty claim is final.

Receipt is required for availing warranty services

Jurisdiction: All disputes are subject to Bangalore court's jurisdiction.

Our Products	<ul style="list-style-type: none"> ◆Chainsaws◆Brush Cutters and Accessories◆Harvesters◆ ◆Engines and Water Pumps◆Hand Tools◆Garden Tools ◆ ◆Cultivators and Accessories◆Sprayers and Accessories◆ ◆Transplanter and Post Hole Digger ◆ Milking Machines ◆
---------------------	---

This warranty is null & void, if you fail to register the warranty with KisanKraft by sending the KisanKraft Copy with dealer's stamp.

KisanKraft Limited (formerly known as KisanKraft Machine Tools P Ltd)

CONTENTS

BEFORE GETTING STARTED..... 8

APPLICATION..... 8

SAFETY INSTRUCTIONS 8

OPERATION - (KK-PS1000/1500/2000/3000/5000/8000, KK-11L)..... 10

STRUCTURE, WORKING PRINCIPLE & CHARACTERISTICS 10

OPERATION - (KK-12L, 16L) / KK-KMS-8617 11

TECHNICAL SPECIFICATION 12

TROUBLE SHOOTING 13

MAINTENANCE AND STORAGE 13

PARTS DIAGRAM & LIST 14

This warranty is null & void, if you fail to register the warranty with KisanKraft by sending the KisanKraft Copy with dealer’s stamp.

KisanKraft Limited (formerly known as KisanKraft Machine Tools P Ltd)

Product	Agricultural Sprayer (Manual) / Agricultural Knapsack Sprayer (Manual)	KisanKraft Invoice Date	
Brand	KisanKraft	KisanKraft Invoice No.	
Model	<input type="checkbox"/> KK-PS1000, KK-TS1000, KK-PS1500, KK-PS2000, <input type="checkbox"/> KK-PS3000, KK-PS5000, KK-PS8000, <input type="checkbox"/> KK-11L, KK-12L, KK-16L <input type="checkbox"/> KK-KMS-8617		
WARRANTY PERIOD	6 MONTHS	FOR THE SPECIFIED PERIOD FROM THE DATE OF SALE OR DELIVERY WHICHEVER IS EARLIER.	
Dealer's Invoice Date		Dealer's Invoice No.	
Buyer's Info (Name, Address, Phone, etc.):		Dealer's Stamp (Address, Phone, TIN, etc.):	
Buyer's Sign		Dealer's Sign	

What is covered: KisanKraft Limited and its manufacturers warrant this product to be free from defects in material or workmanship. All parts defective in material and workmanship are covered.

This warranty will only cover defects arising under normal usage.

This warranty is limited to repair or replacement by KisanKraft Limited or its manufacturers at the premises of Authorized Dealers, of such parts as appear to KisanKraft or its manufacturers, upon inspection, to be defective in material and/or workmanship. KisanKraft or its manufacturers make no warranty with respect to trade accessories not manufactured or sold by them.

What is not covered: The *warranty shall become null and void* and neither KisanKraft Limited nor any of its manufacturers, nor its authorized dealers assumes any responsibility, if the failure was caused by the following:

- (1) Operation of product with incorrect fuel or lubricants, (2) Incorrect usage of machine or misuse, (3) Lack of maintenance, (4) Negligence, (5) Accident or physical damage, (6) Repairs made by unauthorized parties and/or with unauthorized parts, (7) Improper set up, adjustments, tampering or altered products

Note: The purchase is not contingent upon a product demonstration. The purchaser shall satisfy himself with the product, including any product demonstration or verification of any function, before buying. KisanKraft Limited or its authorized dealers including online sellers, shall not be liable to give any on-site demonstration after purchase of any of the product

This warranty is null & void, if you fail to register the warranty with KisanKraft by sending the KisanKraft Copy with dealer's stamp.

KisanKraft Limited (formerly known as KisanKraft Machine Tools P Ltd)

🌐: www.kisankraft.com ✉: info@kisankraft.com ☎: +91.80. 22178200

Product	Agricultural Sprayer (Manual) / Agricultural Knapsack Sprayer (Manual)	KisanKraft Invoice Date	
Brand	KisanKraft	KisanKraft Invoice No.	
Model	<input type="checkbox"/> KK-PS1000, KK-TS1000, KK-PS1500, KK-PS2000, <input type="checkbox"/> KK-PS3000, KK-PS5000, KK-PS8000, <input type="checkbox"/> KK-11L, KK-12L, KK-16L <input type="checkbox"/> KK-KMS-8617		
WARRANTY PERIOD	6 MONTHS	FOR THE SPECIFIED PERIOD FROM THE DATE OF SALE OR DELIVERY WHICHEVER IS EARLIER.	
Dealer's Invoice Date		Dealer's Invoice No.	
Buyer's Info (Name, Address, Phone, etc.):		Dealer's Stamp (Address, Phone, TIN, etc.):	
Buyer's Sign		Dealer's Sign	

What is covered: KisanKraft Limited and its manufacturers warrant this product to be free from defects in material or workmanship. All parts defective in material and workmanship are covered.

This warranty will only cover defects arising under normal usage.

This warranty is limited to repair or replacement by KisanKraft Limited or its manufacturers at the premises of Authorized Dealers, of such parts as appear to KisanKraft or its manufacturers, upon inspection, to be defective in material and/or workmanship. KisanKraft or its manufacturers make no warranty with respect to trade accessories not manufactured or sold by them.

What is not covered: The *warranty shall become null and void* and neither KisanKraft Limited nor any of its manufacturers, nor its authorized dealers assumes any responsibility, if the failure was caused by the following:

- (1) operation of product with incorrect fuel or lubricants, (2) Incorrect usage of machine or misuse, (3) Lack of maintenance, (4) Negligence, (5) Accident or physical damage, (6) Repairs made by unauthorized parties and/or with unauthorized parts, (7) Improper set up, adjustments, tampering or altered products

Note: The purchase is not contingent upon a product demonstration. The purchaser shall satisfy himself with the product, including any product demonstration or verification of any function, before buying. KisanKraft Limited or its authorized dealers, including online sellers, shall not be liable to give any on-site demonstration after purchase of any of the product

This warranty is null & void, if you fail to register the warranty with KisanKraft by sending the KisanKraft Copy with dealer's stamp.

KisanKraft Limited (formerly known as KisanKraft Machine Tools P Ltd)

🌐: www.kisankraft.com ✉: info@kisankraft.com ☎: +91.80. 22178200



Wide Range of Products for Every Need



For more information give **MISSED CALL: 07676065555**



Many of our products have BIS: ISI certification.



Important: (1) Normal maintenance and adjustments to the product is the responsibility of the customer. (2) Normal wear and tear is not covered under warranty.(3) Rubber/plastic parts and consumables such as blades, clutch and clutch-bell, spark-plugs, nylon line, air-filters, fuel-filters, oil seals etc. are not covered under the warranty.

No Warranty On Electrical Motor / Electrical Parts / Battery Etc.

Incidental / Consequential Loss: KisanKraft Limited or its manufacturers will not be liable for general damages, including bodily injuries, or for incidental or consequential damages including, but not limited to, loss of use, loss of profits, loss of production, expense of substitute equipment or other commercial loss or damage.

Limitation of Liability: This limited warranty is in lieu of all other express warranties, obligations, or liabilities. Any implied warranties, obligations or liabilities, including, but not limited to, any implied warranty of merchantability shall be limited in duration to the applicable warranty period. Any action for breach of any warranties hereunder, including, but not limited to, any implied warranty of merchantability must be brought within the applicable warranty period.

Modifications of Warranty: No agent, representative, dealer, or employee of KisanKraft Limited or any of its manufacturers has the authority to increase or alter the obligations of this warranty.

Assignment / Transfer of warranty: The warranty cannot be assigned and shall not transfer if the product is resold by the first buyer. The above warranties are extended to the first end user (original purchaser), and no warranty is made, nor authorized to be made assignable on resale by the first end user.

What you must do to obtain limited warranty service: To obtain performance of any obligation under this warranty for failure during the applicable warranty period, deliver the defective product, to the nearest Authorized Dealer. KisanKraft Limited, its manufacturers and its dealers reserve the right to inspect the claimed defective part(s) to determine if the malfunction is the result of a defect covered by this warranty. Please note that the decision of KisanKraft Machine Tools Pvt Ltd with respect to any warranty claim is final.

Receipt is required for availing warranty services

Jurisdiction: All disputes are subject to Bangalore court's jurisdiction.

Our Products

- ◆Chainsaws◆Brush Cutters and Accessories◆Harvesters◆
- ◆Engines and Water Pumps◆Hand Tools◆Garden Tools◆
- ◆Cultivators and Accessories◆Sprayers and Accessories◆
- ◆Transplanter and Post Hole Digger ◆ Milking Machines ◆

This warranty is null & void, if you fail to register the warranty with KisanKraft by sending the KisanKraft Copy with dealer's stamp.

KisanKraft Limited (formerly known as KisanKraft Machine Tools P Ltd)

BEFORE GETTING STARTED

Thank you for your purchase and use of our products. In order to avoid accidents or injury, **please read this manual carefully** before using. After reading, preserve it for further reference.

APPLICATION

The pressure sprayers developed by our company are safe, economic and efficient in nature. Its structure is new and modelling is unique making it highly comfortable for usage and spraying evenly. It is especially suitable for prevention and cure of diseases and insect's violation of crops, for blowers, plants and gardens, for environmental sanitation of public places, epidemic prevention near hotels, stations and sanitation of livestock poultry sheds.

SAFETY INSTRUCTIONS

1. Read this manual carefully, be sure you understand how to operate this machine properly before you use it.
2. Protective Clothing:

- Wear flange cap.
- Wear dirt/fog-proof glasses.
- Wear gauze mask.
- Wear long gloves.
- Wear coat guarding against poisons.
- Wear boots.

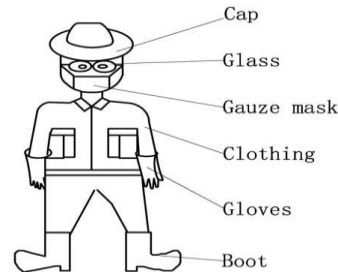

3. Following personnel should not use the machine:
 - Mentally challenged.
 - Drunk.
 - Under the age of 18 or older people.
 - Person with no knowledge of the machine.
 - Tired person or patient and others who cannot operate the machine normally.
 - A person who has just exercised strenuously or has not slept enough. Women feeding breast milk to the baby or is pregnant.
4. Spraying
 - It is fine to carry out an operation during cool weather with little wind. For example, early in the mornings or in the late afternoons as this can reduce the evaporation and drift of chemicals and improve the protective effect.
 - The operator should move windward.
 - Do not spray the pesticide at other people, animals and foodstuff.
 - If your mouth or eyes are spattered with chemicals, wash them with clean water and then visit a doctor.

KisanKraft has a large range of products to serve the farmers. A list of our products is given below:

<p>Brush Cutters and Accessories</p> <ul style="list-style-type: none"> Brush Cutter/Power Weeder Backpack Brush Cutter Tea Pruner Pole pruner with Engine Reaper Attachment Blades-Circular Blades (2 &3 points) Baffle Nylon Rope Tap & Go <p>Chainsaws</p> <ul style="list-style-type: none"> Petrol Chainsaw Electric Chainsaw Chain Sharpening Machine <p>Engines and Water Pumps</p> <ul style="list-style-type: none"> Engine –Diesel-(Horizontal) Engine –Diesel(Vertical) Engine-Kerosene Water Pump with Petrol Engine Water Pump with Kerosene Engine Water Pump with Diesel Engine <p>Hand Tools</p> <ul style="list-style-type: none"> Secateurs Folding Saw Garden Rake Garden Shovel Hedge Shear Lopper Telescopic Hedge Shear Telescopic Lopping Shear Tree Pruner Telescopic Steel Pipe & Fruit Picker Bag Sheep Shear <p>Garden Tools</p> <ul style="list-style-type: none"> Electric Pressure Washer Hedge Trimmer Lawn Mower (Electric, Petrol & Manual) Leaf Blower 	<p>Cultivators and Accessories</p> <ul style="list-style-type: none"> Petrol and Diesel <p>Sprayers and Accessories</p> <ul style="list-style-type: none"> Battery Sprayer Portable Power Sprayer Trolley Sprayer Manual Knapsack Sprayer Manual Pressure Sprayer Rose Cans Hose Crimping Machine HTP Sprayer HTP Delivery Hose HTP Hose Reel HTP Stand HTP Gun / Lance(Brass Rod) Knapsack Power Sprayer Mister / Duster / Granuel Spreader HTP Sprayer Set with Diesel Engine HTP Sprayer Set with Kerosene Engine Fogging Machine <p>Milking Machine</p> <ul style="list-style-type: none"> Wood Shredder Fodder Ensiling Chaff Cutter Fodder Grinder Chaff Cutter Fodder Mini Chaff Cutter <p>Harvester</p> <ul style="list-style-type: none"> Maize Sheller Maize Sheller + Dehusker Maize Combine Harvester Onion Digger Carlotti Italy Tea Leaf Harvester Sugarcane Combine Harvester Sugarcane Leaf Stripper <p>Transplanter and Post Hole Digger</p> <ul style="list-style-type: none"> Paddy Transplanter (2 & 8 Rows) Transplanter-Vegetable & Tobacco Post Hole Digger(4" to 14" Augers)
---	---

Part No	Part Name	Part No	Part Name
1	Container	28	Handle
2	Container Bottom	29	Handle Sealing Washer
3	Container Cap	30	Switch Body
4	Air Intake Plug	31	Small Filter
5	Filter	32	Switch Pin
6	Operation Arm	33	Limited Cap
7	Operation Arm Cover	34	Switch Sealing Washer
8	Split Pin 2.5X21	35	Press Plate
9	Operation Arm Fixed Ring	36	Switch Nut
10	Operation Arm Clamp	37	Spring
11	Bolt M9	38	Valve Core
12	Back Belt	39	Valve Core O-Ring
13	Belt Hook	40	Spindle O Ring
14	Belt Buckle	41	Split Sleeve
15	Air Chamber Cover	42	Spindle
16	Sealing Ball Seat	43	Buy #47 Spray Head
17	Air Tube	44	Buy #47 Spray Head
18	Locking Cap	45	Buy #47 Spray Head
19	Sealing Ball	46	Buy #47 Spray Head
20	Bowl	47	Spray Head
21	Suction Tube	48	Fixed Buckle
22	Buy #50 Air Chamber With Cap	49	Felt
23	Ream Cover	50	Air Chamber With Cap
24	Hose Nut	51	Fan Style Spray Head
25	Hose	52	30 Double Spray Head
26	Spindle Nut	53	4-Hole Adjustable Head
27	Hose Cover		

- If the operator has a headache or dizziness, should stop working at once and consult a doctor immediately.
 - For the operator's safety, misting/dusting must be carried out strictly according to the instruction of the chemicals and agricultural requirements.
 - Spray over, according to pesticide manual to clean out any residual spray mixture in chemical tank.
 - After spraying always wash your hands and face thoroughly.
5. Warning:
- Check if the parts in the package coincide with the packing list.
 - Don't use it to spray corrosive liquids, strong acid or alkali, coal, oil and other volatile liquid in order not to catch a fire or get any burns.
 - It will harm persons and crop if the chemical liquid is mixed improper. Please read the introduction of pesticide before using it.
 - It is prohibited to put the pesticide into other containers in order not to prevent any accidental consumption.
 - In order to avoid incidents incurred by clinging to the pesticide, the operator must wear flange cap, fog-proof glasses, gauze mask, long gloves, and coat guarding against poisons, boots and some other protective clothing.
 - After operating, the operator must wash the whole body with water and soap. In the meantime, the operator must wash eyes with clean water, and change clothes every day within the period of operation.
 - Don't let the deposit or the water used for cleaning the machine flow into river, lake, pond, in order not to avoid pollution.
 - The machine should cleaned completely, be dried and charged fully after using, and then should be kept in a cool and windy place.
 - Before turning on the switch, do not swing the operation arm continuously for a long time, in order to avoid damage to the machine.
 - Do not operate under high temperatures for prolonged time.
 - It is also strictly forbidden to use high toxic and high residual pesticide for the insects of vegetables melons, guards, fruits, tea and medical herbs. Strictly control the safe period collection after applying pesticide.
 - After operation, please clean the sprayer, in order to avoid the medicinal liquid corroding the spray machine or blocking up the spray head. It also avoids residual pesticide mixing with the next different pesticide which may cause a chemical reaction and influence the effect of the pesticide or harm the crops.
 - If the sprayer is not used for a long period or continuously operated for several days, please add Vaseline to the sealing washer and activating parts to reduce wear and to ease obstruction.

OPERATION - (KK-PS1000/1500/2000/3000/5000/8000, KK-11L)

1. Pull up the nozzle of pressure release valve, to release the pressure, then unscrew the air pump and take the pump out of the tank.
2. Fill the chemical(spraying material) and close the lid such that it is air tight
3. Pump the liquid until the pressure builds up in the tank.
4. Now lock the pump handle.
5. Press the trigger to spray.
6. Once the spraying process is over, before opening the lid, ensure no pressure is present in the container. To achieve this, release the pressure by pulling up the pressure regulator.
7. Please clean inside the tank carefully after use.

STRUCTURE, WORKING PRINCIPLE & CHARACTERISTICS
(KK-12L, 16L)/ KK-KMS-8617

Structure: The machine is composed of the following:

1. Container of liquid
2. Pump and air chamber
3. Spraying system (including rubber hose and components, switch, sprayer spindle and head)
4. Operation arm and components
5. Backpack belt system

Working principle: By swinging the operation arm and components, the pump bowl rises up and down which allows the sealing ball to turn on and off. This in turn makes the pressure in the air chamber rise up and down which then forces the medicinal liquid into the chamber, the liquid can then go through the spraying system and spurt out as spray.

Characteristics:

1. The external form is an imitation of the human backs curve and the combination of the air chamber and pump located in the liquid container makes the whole structure compact and safe with no leakage.
2. The operation arm uses an action connecting style so that it can be installed on both sides (mutually changeable). Thus It is convenient and quick in action and the user can operate it accordingly with the right or left hand reducing the labour intensity.
3. Various spray heads can be fitted for use in different tasks, to achieve a fine spray and sprinkle effects.
4. The chosen materials for the machine are resistant to acid, alkalinity and corrosion. The machine is sealed hermetically and is very durable.

KK-16L

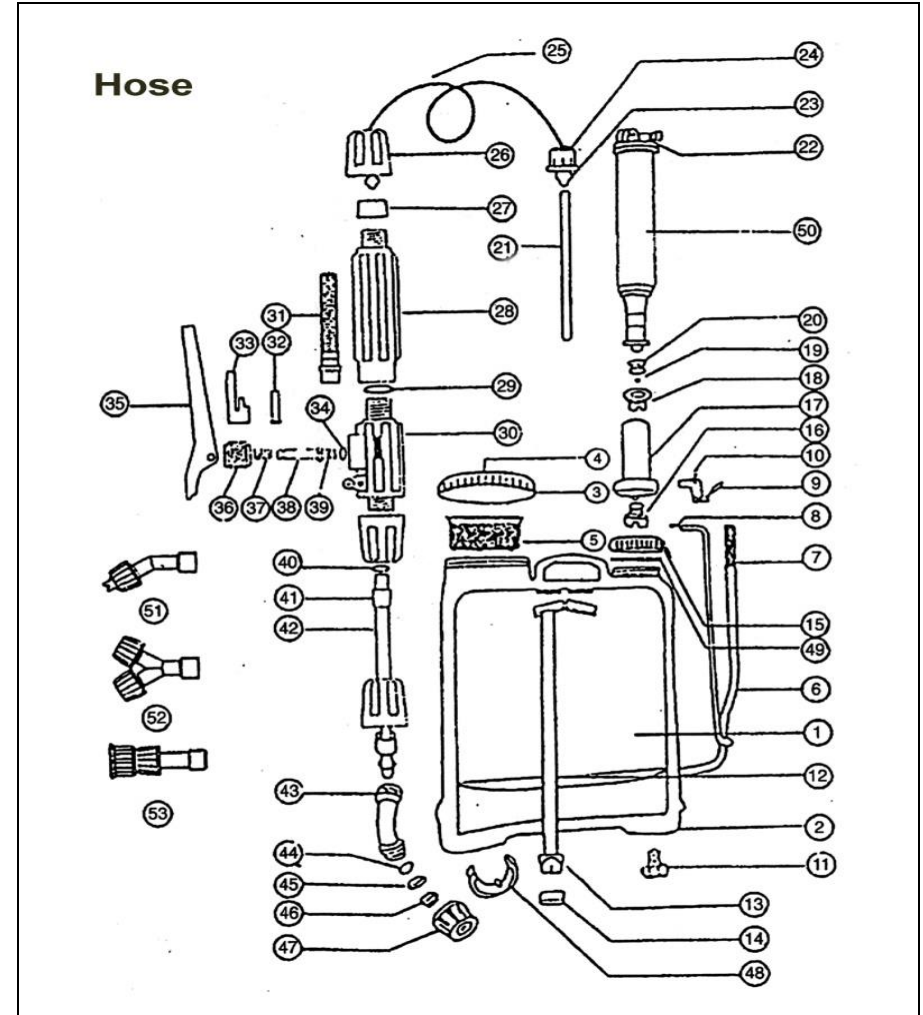

Sl. No	Part No.	Part Name	Sl. No	Part No.	Part Name
24	7	Rim Cover/Flared Sheath	54	42	Operation Arm Fix Ring/Rocker Bar Snap
25	8	Hose Cover/Plastic Tube Sleeve	55	43	Rocker Bar Sheath
26	9	Hose/Plastic Tube	56	44	Rocker Bar Assy
27	10	Air Intake Plug/Ventilator Plug	57	45	Screw M5x8
28	11	Container Cap/Tank Lid	58	46	Fan-Style Head
29	12	Tank Seal Washer	59	47	Dual Head
30	13	Filter/ Big Filter Screen	60	48	Adjustable Head With Four Apertures

OPERATION - (KK-12L, 16L) / KK-KMS-8617

After the packing box of new machine is opened please check all the parts conform to the packing list. Then assemble the machine as per the structure sketch. Before use please wrench the cap off the container. Pour the compounded medicinal liquid through the filter into the container slowly, then close the cap tightly and put the machine on your back. After the pressure in the air chamber is boosted swing the operation arm and then press the switch component to begin spray operation. It can be point-spray or it can be continuous spray. At the same time adjust the nut according to the requirement of the crops in order to improve the quality of spraying.

Choose the different spray-head for spraying correctly. Accompanying with the machine delivered there are 3 kinds of spray heads:

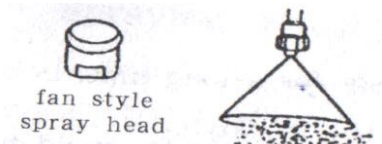
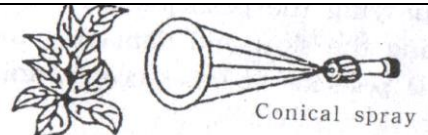
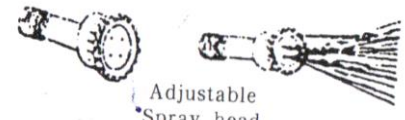
<p>Fan style spray: This sprays evenly and is suitable for spraying on low and short stalked crops and for the spraying of weed killer. Keep the spray head stable and spray in the same direction as the wind.</p>	 <p>fan style spray head</p>
<p>Conical spray head: This can be used for spraying pesticide and insecticide, to prevent diseases and kill insects. Spray in the same direction as the wind.</p>	 <p>Conical spray head</p>
<p>4 Hole adjustable spray: This can be used for spraying on the high stalk crops and fruit trees. Its shortcoming is the serious running off the medicinal liquid.</p>	 <p>Adjustable Spray head</p>

TECHNICAL SPECIFICATION

Hand Operated Pressure Sprayer							
Model	KK-TS-1000 (Trigger) / KK-PS1000	KK-PS1500	KK-PS2000	KK-PS3000	KK-PS5000	KK-PS8000	KK-11L
Tank capacity (liter)	1	1.5	2	3	5	8	11

Knapsack Manual Sprayer		
Model	KK-12L	KK-16L / KK-KMS-8617
Output capacity	30 to 70 litre/hour (liquid)	
Cylinder & lance	HDPE	
Tank capacity(L)	12	16
Weight (kg)	2.8	3

SI. No	Part No.	Part Name	SI. No	Part No.	Part Name
1	1	Spray Head	31	15	Shoulder Pad
2	1-1	Buy #1 Spray Head	32	16	Container/Tank
3	1-2	Buy #1 Spray Head	33	17	Strap Buckle
4	1-3	Buy #1 Spray Head	34	18	Strap
5	1-4	Buy #1 Spray Head	35	19	Adjustment Ring Of Strap
6	1-5	Buy #1 Spray Head	36	20	Fixing Ring Of Strap
7	2	Spindle /Sprayer Rod	37	21	Lock Pin Of Strap
8	3	Spindle Nut/ Rod Nut	38	26	Sealing Ball
9	4	Split Sleeve/Open End Sheath	39	27	Air Chamber Cap/Lid
10	5	Spindle O Ring	40	28	Felt-Air Chamber
11	6	Switch Assy	41	29	Pump Cylinder Seal Washer
12	6-1	Limit Cap	42	30	Pump Cylinder
13	6-2	Press Plate	43	31	Pump Cylinder Seal Ring
14	6-3	Switch Nut	44	32	Locking Cap/Round Ball Seat
15	6-4	Spring	45	33	O-Ring
16	6-5	Valve core/Valve Plug	46	34	Bowl /Piston
17	6-6	Valve Core O-ring/Valve Plug O Ring	47	35	Air Chamber
18	6-7	Switch Sealing Washer	48	36	Split Pin 2x25
19	6-8	Switch Pin	49	37	Hose-Suction
20	6-9	Switch Body	50	38	O-ring 12.4x2.65
21	6-10	Handle Sealing Washer/Ring	51	39	Plastic Tube Core
22	6-11	Small Filter/Filter Screen	52	40	Plastic Tube Nut
23	6-12	Handle	53	41	Rocker Bar Clamp

KK-12L

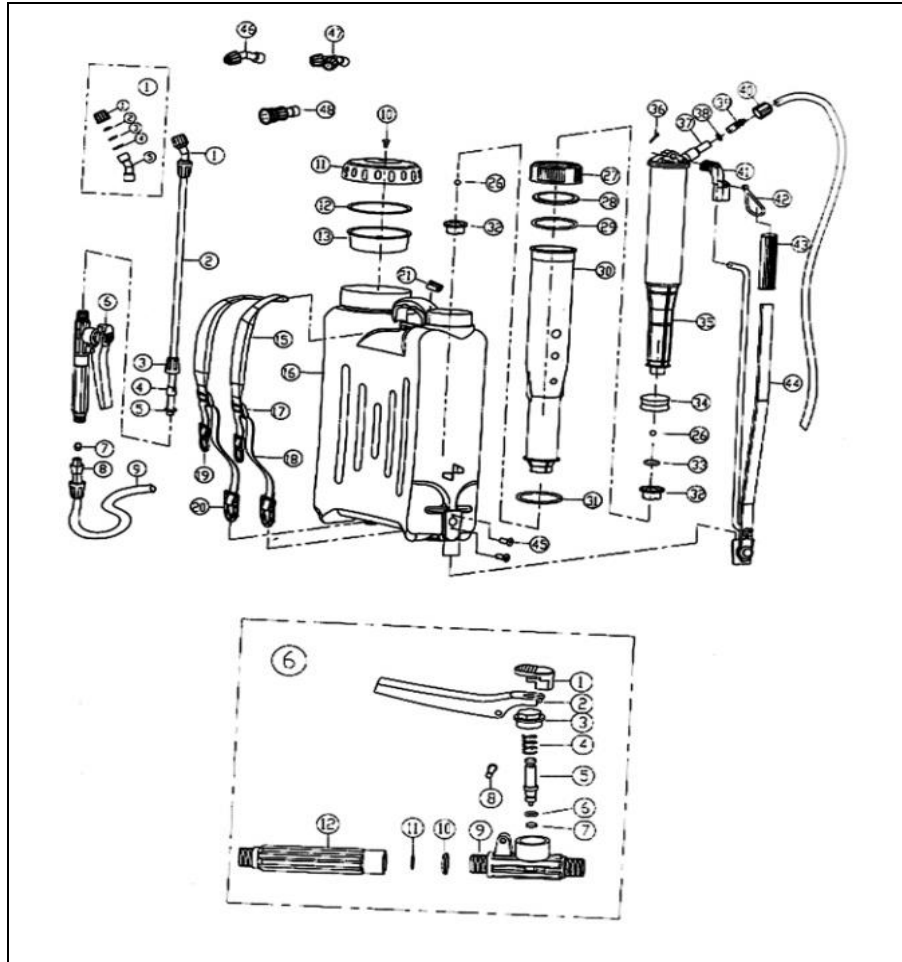

TROUBLE SHOOTING

Problem	Cause	Remedy
The sprayer has Leakage and is not spraying well.	Sealing plate is damaged or not wrenched firm	Replace the sealing plate or wrench firm
The operation arm exerts more pressure while pumping	Spray head or filter block up	Clean the filter and spray head, add Vaseline to the activating parts.
Need to apply less pressure while pumping the operation arm	Abrasion of the bowl or the sealing ball.	Change the bowl or sealing ball.
The operation arm exerts no pressure while pumping	Sealing ball is missing or removed	Fix the sealing ball properly

MAINTENANCE AND STORAGE

Daily maintenance:

The following maintenance should be done after daily job.

1. Cleaning the dust on the surface of the machine.
2. Clean the chemical tank with clean water and wipe it dry.
3. Check if there is any leakage of water. If there is a leakage, remedy procedures are to be taken.
4. Check to see if the screws are loose or lost. If so, please tighten the screw or replace.
5. The machine after maintenance should be stored in a place which is dry and has good ventilation. It must be far away from any fire source and sunlight.

Long term Storage:

The machine which is to be stored t for a long time should be maintained as follows:

1. Clean the machine surface carefully.
2. Discard any chemical in the tank and the pump, clean them with clean water.
3. All the plastic parts must neither be exposed to the sunlight nor pressed by heavy matter.
4. Cover the machine with plastic dustcoat and store in a dry and clean place.

PARTS DIAGRAM & LIST

(KK-PS1000 / 1500 / 2000)

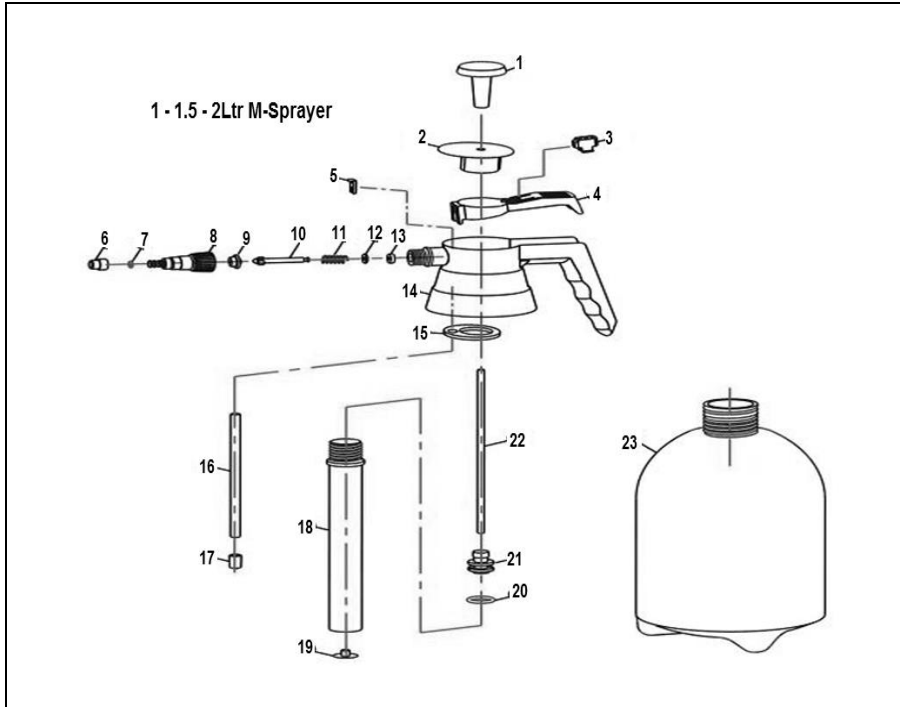

- 1. Pressure Handle
- 2. Handle Cap
- 3. Trigger
- 4. Trigger Handle
- 5. Trigger Lock
- 6. Nozzle
- 7. Nozzle O-ring (Front)
- 8. Nozzle Assembly
- 9. Nozzle O-ring (Back)
- 10. Pressure Rod
- 11. Pressure Spring
- 12. Pressure O-ring (Front)

- 13. Pressure O-ring (Back)
- 14. Bottle Handle
- 15. Bottle O-ring
- 16. Outlet Tube
- 17. Outlet Filter
- 18. Pressure Chamber
- 19. Oil-Seal
- 20. Pressure Chamber O-Ring
- 21. Pressure Chamber Oil-Seal/HOUSING
- 22. Pressure Chamber Rod
- 23. Bottle

KK-PS5000 / 8000, KK- 11L

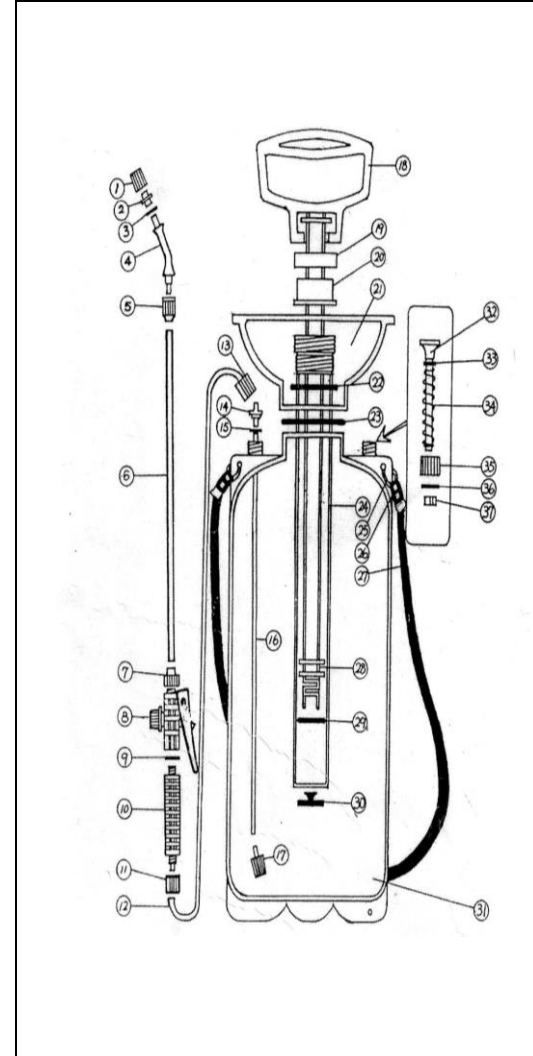

- 1. Nozzle
- 2. Connector (Nozzle)
- 3. O-ring (nozzle)
- 4. Connector (Lance)
- 5. Cap upper (Lance)
- 6. Lance
- 7. Cap Lower (Lance)
- 8. Pressure Screw/switch Assy
- 9. O-ring Trigger Handle
- 10. Trigger Handle
- 11. Cap (Delivery Tube + Trigger)
- 12. Delivery Hose /Tube
- 13. Cap (Delivery Tube)
- 14. Joint (Outlet)
- 15. O-ring (Outlet)
- 16. Outlet Tube
- 17. Filter (outlet tube)
- 18. Pump Handle
- 19. Cover-Pump Handle
- 20. Cap-Pressure Chamber
- 21. Lid (Cone)
- 22. O-Ring (Medium)
- 23. O-Ring (Large)
- 24. Pressure Chamber
- 25. Ring (Belt)
- 26. Buckle (Belt)
- 27. Belt
- 28. O-Ring Housing (Pressure Chamber)
- 29. O-Ring Bottom (Pressure Chamber)
- 30. Oil Seal (Pressure Chamber)
- 31. Tank
- 32. Rod-Safety Valve
- 33. O-Ring (Safety Valve)
- 34. Spring (Safety Valve)
- 35. Cap (Safety Valve)
- 36. O-Ring (Safety Valve Lock)
- 37. Lock - Safety Valve