

Important: (1) Normal maintenance and adjustments to the product is the responsibility of the customer. (2) Normal wear and tear is not covered under warranty (3) Rubber/plastic parts and consumables such as blades, clutch and clutch-bell, spark-plugs, nylon line, air-filters, fuel-filters, oil seals etc. are not covered under the warranty.

No Warranty On Electrical Motor / Electrical Parts / Battery Etc

Incidental / Consequential Loss: KisanKraft Limited or its manufacturers will not be liable for general damages, including bodily injuries, or for incidental or consequential damages including, but not limited to, loss of use, loss of profits, loss of production, expense of substitute equipment or other commercial loss or damage.

Limitation of Liability: This limited warranty is in lieu of all other express warranties, obligations, or liabilities. Any implied warranties, obligations or liabilities, including, but not limited to, any implied warranty of merchantability shall be limited in duration to the applicable warranty period. Any action for breach of any warranty hereunder, including, but not limited to, any implied warranty of merchantability must be brought within the applicable warranty period.

Modifications of Warranty: No agent, representative, dealer, or employee of KisanKraft Limited or any of its manufacturers has the authority to increase or alter the obligations of this warranty.

Assignment / Transfer of warranty: The warranty cannot be assigned and shall not transfer if the product is resold by the first buyer. The above warranties are extended to the first end user (original purchaser), and no warranty is made, nor authorized to be made assignable on resale by the first end user.

What you must do to obtain limited warranty service: To obtain performance of any obligation under this warranty for failure during the applicable warranty period, deliver the defective product, to the nearest Authorized Dealer. KisanKraft Limited, its manufacturers and its dealers reserve the right to inspect the claimed defective part(s) to determine if the malfunction is the result of a defect covered by this warranty. Please note that the decision of KisanKraft Limited with respect to any warranty claim is final.

Receipt is required for availing warranty services

Jurisdiction: All disputes are subject to Bangalore court's jurisdiction.

Our Products	<ul style="list-style-type: none"> ◆Chainsaws◆Brush Cutters and Accessories◆Harvesters◆ ◆Engines and Water Pumps◆Hand Tools◆Garden Tools◆ ◆Cultivators and Accessories◆Sprayers and Accessories◆ ◆Transplanter and Post Hole Digger ◆Milking Machines◆
---------------------	--

This warranty is null & void, if you fail to register the warranty with KisanKraft by sending the KisanKraft Copy with dealer's stamp.

KisanKraft Limited (formerly known as KisanKraft Machine Tools P Ltd)

🌐: www.kisankraft.com ✉: info@kisankraft.com ☎: +91.80. 22178200

Product	DIESEL ENGINE-VERTICAL	KisanKraft Invoice Date	
Brand	KisanKraft	KisanKraft Invoice No.	
Model	<input type="checkbox"/> KK-DEV-370F <input type="checkbox"/> KK-DEV-378F <input type="checkbox"/> KK-DEV-386F		
WARRANTY PERIOD	6 MONTHS	FOR THE SPECIFIED PERIOD FROM THE DATE OF SALE OR DELIVERY WHICHEVER IS EARLIER.	
Dealer's Invoice Date		Dealer's Invoice No.	
Buyer's Info (Name, Address, Phone, etc.):		Dealer's Stamp (Address, Phone, TIN, etc.):	
Buyer's Sign		Dealer's Sign	

What is covered: KisanKraft Limited and its manufacturers warrant this product to be free from defects in material or workmanship. All parts defective in material and workmanship are covered.

This warranty will only cover defects arising under normal usage.

This warranty is limited to repair or replacement by KisanKraft Limited or its manufacturers at the premises of Authorized Dealers, of such parts as appear to KisanKraft or its manufacturers, upon inspection, to be defective in material and/or workmanship. KisanKraft or its manufacturers make no warranty with respect to trade accessories not manufactured or sold by them.

What is not covered: The warranty shall become null and void and neither KisanKraft Limited nor any of its manufacturers, nor its authorized dealers assumes any responsibility, if the failure was caused by the following:

- (1) Operation of product with incorrect fuel or lubricants,
- (2) Incorrect usage of machine or misuse,
- (3) Lack of maintenance,
- (4) Negligence,
- (5) Accident or physical damage,
- (6) Repairs made by unauthorized parties and/or with unauthorized parts,
- (7) Improper set up, adjustments, tampering or altered products

This warranty is null & void, if you fail to register the warranty with KisanKraft by sending the KisanKraft Copy with dealer's stamp.

KisanKraft Limited (formerly known as KisanKraft Machine Tools P Ltd)

🌐: www.kisankraft.com ✉: info@kisankraft.com ☎: +91.80. 22178200

Important: (1) Normal maintenance and adjustments to the product is the responsibility of the parts and consumables such as blades, clutch and clutch-bell, spark-plugs, nylon line, air-filters, fuel-filters, oil seals etc. are not covered under the warranty.

No Warranty On Electrical Motor / Electrical Parts / Battery Etc.

Incidental / Consequential Loss: KisanKraft Limited or its manufacturers will not be liable for general damages, including bodily injuries, or for incidental or consequential damages including, but not limited to, loss of use, loss of profits, loss of production, expense of substitute equipment or other commercial loss or damage.

Limitation of Liability: This limited warranty is in lieu of all other express warranties, obligations, or liabilities. Any implied warranties, obligations or liabilities, including, but not limited to, any implied warranty of merchantability shall be limited in duration to the applicable warranty period. Any action for breach of any warranties hereunder, including, but not limited to, any implied warranty of merchantability must be brought within the applicable warranty period.

Modifications of Warranty: No agent, representative, dealer, or employee of KisanKraft Limited or any of its manufacturers has the authority to increase or alter the obligations of this warranty.

Assignment / Transfer of warranty: The warranty cannot be assigned and shall not transfer if the product is resold by the first buyer. The above warranties are extended to the first end user (original purchaser), and no warranty is made, nor authorized to be made assignable on resale by the first end user.

What you must do to obtain limited warranty service: To obtain performance of any obligation under this warranty for failure during the applicable warranty period, deliver the defective product, to the nearest Authorized Dealer. KisanKraft Limited, its manufacturers and its dealers reserve the right to inspect the claimed defective part(s) to determine if the malfunction is the result of a defect covered by this warranty. Please note that the decision of KisanKraft Limited with respect to any warranty claim is final.

Receipt is required for availing warranty services

Jurisdiction: All disputes are subject to Bangalore court's jurisdiction.

Our Products	<ul style="list-style-type: none"> ◆Chainsaws◆Brush Cutters and Accessories◆Harvesters◆ ◆Engines and Water Pumps◆Hand Tools◆Garden Tools◆ ◆Cultivators and Accessories◆Sprayers and Accessories◆ ◆Transplanter and Post Hole Digger ◆Milking Machines◆
---------------------	--

This warranty is null & void, if you fail to register the warranty with KisanKraft by sending the KisanKraft Copy with dealer's stamp.

KisanKraft Limited (formerly known as KisanKraft Machine Tools P Ltd)

🌐: www.kisankraft.com ✉: info@kisankraft.com ☎: +91.80. 22178200

Product	DIESEL ENGINE- VERTICAL	KisanKraft Invoice Date	
Brand	KisanKraft	KisanKraft Invoice No.	
Model	<input type="checkbox"/> KK-DEV-370F <input type="checkbox"/> KK-DEV-378F <input type="checkbox"/> KK-DEV-386F		
WARRANTY PERIOD	6 MONTHS	FOR THE SPECIFIED PERIOD FROM THE DATE OF SALE OR DELIVERY WHICHEVER IS EARLIER.	
Dealer's Invoice Date		Dealer's Invoice No.	
Buyer's Info (Name, Address, Phone, etc.):		Dealer's Stamp (Address, Phone, TIN, etc.):	
Buyer's Sign		Dealer's Sign	

What is covered: KisanKraft Limited and its manufacturers warrant this product to be free from defects in material or workmanship. All parts defective in material and workmanship are covered.

This warranty will only cover defects arising under normal usage.

This warranty is limited to repair or replacement by KisanKraft Limited or its manufacturers at the premises of Authorized Dealers, of such parts as appear to KisanKraft or its manufacturers, upon inspection, to be defective in material and/or workmanship. KisanKraft or its manufacturers make no warranty with respect to trade accessories not manufactured or sold by them.

What is not covered: The *warranty shall become null and void* and neither KisanKraft Limited nor any of its manufacturers, nor its authorized dealers assumes any responsibility, if the failure was caused by the following:

- (1) Operation of product with incorrect fuel or lubricants,
- (2) Incorrect usage of machine or misuse,
- (3) Lack of maintenance,
- (4) Negligence,
- (5) Accident or physical damage,
- (6) Repairs made by unauthorized parties and/or with unauthorized parts,
- (7) Improper set up, adjustments, tampering or altered products.

This warranty is null & void, if you fail to register the warranty with KisanKraft by sending the KisanKraft Copy with dealer's stamp.

KisanKraft Limited (formerly known as KisanKraft Machine Tools P Ltd)

🌐: www.kisankraft.com ✉: info@kisankraft.com ☎: +91.80. 22178200



Wide Range of Products for Every Need



For more information give **MISSED CALL: 07676065555**



Many of our products have BIS: ISI certification.



Operation manual

KK-DEV-370F/378F/386F



KisanKraft Limited

(Formerly known as KisanKraft Machine Tools Pvt Ltd)

Sri Huchhanna Tower, #4, 1st Main, 7-A Cross, Maruthi Layout, Dasarahalli,
HAF Post, Hebbal, Bangalore 560024, Karnataka, INDIA

- ◆ Bangalore (HO) ◆ Ahmedabad ◆ Bhopal ◆ Bhubaneswar ◆ Coimbatore ◆
- ◆ Guwahati ◆ Patna ◆ Hubli ◆ Hyderabad ◆ Jaipur ◆ Karnal ◆
- ◆ Kolkata ◆ Lucknow ◆ Jammu ◆ Pune ◆ Raipur ◆ Shimla ◆

KisanKraft has a large range of products to serve the farmers. A list of our products is given below:

<p>Brush Cutters and Accessories</p> <ul style="list-style-type: none"> Brush Cutter/Power Weeder Backpack Brush Cutter Tea Pruner Pole pruner with Engine Reaper Attachment Blades-Circular Blades (2 & 3 points) Baffle Nylon Rope Tap & Go <p>Chainsaws</p> <ul style="list-style-type: none"> Petrol Chainsaw Electric Chainsaw Chain Sharpening Machine <p>Engines and Water Pumps</p> <ul style="list-style-type: none"> Engine –Diesel-(Horizontal) Engine –Diesel(Vertical) Engine-Kerosene Water Pump with Petrol Engine Water Pump with Kerosene Engine Water Pump with Diesel Engine <p>Hand Tools</p> <ul style="list-style-type: none"> Secateurs Folding Saw Garden Rake Garden Shovel Hedge Shear Lopper Telescopic Hedge Shear Telescopic Lopping Shear Tree Pruner Telescopic Steel Pipe & Fruit Picker Bag Sheep Shear <p>Garden Tools</p> <ul style="list-style-type: none"> Electric Pressure Washer Hedge Trimmer Lawn Mower (Electric, Petrol & Manual) Leaf Blower 	<p>Cultivators and Accessories</p> <ul style="list-style-type: none"> Petrol and Diesel <p>Sprayers and Accessories</p> <ul style="list-style-type: none"> Battery Sprayer Portable Power Sprayer Trolley Sprayer Manual Knapsack Sprayer Manual Pressure Sprayer Rose Cans Hose Crimping Machine HTP Sprayer HTP Delivery Hose HTP Hose Reel HTP Stand HTP Gun / Lance(Brass Rod Knapsack Power Sprayer Mister / Duster / Granuel Spreader HTP Sprayer Set with Diesel Engine HTP Sprayer Set with Kerosene Engine Fogging Machine <p>Milking Machine</p> <ul style="list-style-type: none"> Wood Shredder Fodder Ensiling Chaff Cutter Fodder Grinder Chaff Cutter Fodder Mini Chaff Cutter <p>Harvester</p> <ul style="list-style-type: none"> Maize Sheller Maize Sheller + Dehusker Maize Combine Harvester Onion Digger Carlotti Italy Tea Leaf Harvester Sugarcane Combine Harvester Sugarcane Leaf Stripper <p>Transplanter and Post Hole Digger</p> <ul style="list-style-type: none"> Paddy Transplanter (2 & 8 Rows) Transplanter-Vegetable & Tobacco Post Hole Digger(4" to 14" Augers)
--	--

4. Incomplete combustion	Check injector quality and if compression force is sufficient
E. Stop the engine immediately in case of any of the following circumstances:	
1. Fluctuating rotary speed	Check speed regulating system, air mixing in fuel passage and evacuate the air.
2. Abnormal noise suddenly	Check each moving part for any damage
3. Black smoke in exhaust	Check the fuel system for normal oil supply, particularly the injector.

CONTENTS

Before Getting Started 8

Safety Instructions 8

Technical Specifications..... 9

Assembly..... 10

Operation..... 10

Starting the Engine..... 13

Stopping the Engine..... 19

Maintenance..... 19

Long Term Storage..... 20

Troubleshooting 21

Product	DIESEL ENGINE- VERTICAL	KisanKraft Invoice Date	
Brand	KisanKraft	KisanKraft Invoice No.	
Model	<input type="checkbox"/> KK-DEV-370F <input type="checkbox"/> KK-DEV-378F <input type="checkbox"/> KK-DEV-386F		
WARRANTY PERIOD	6 MONTHS	FOR THE SPECIFIED PERIOD FROM THE DATE OF SALE OR DELIVERY WHICHEVER IS EARLIER.	
Dealer's Invoice Date		Dealer's Invoice No.	
Buyer's Info (Name, Address, Phone, etc.):		Dealer's Stamp (Address, Phone, TIN, etc.):	
Buyer's Sign		Dealer's Sign	

What is covered: KisanKraft Limited and its manufacturers warrant this product to be free from defects in material or workmanship. All parts defective in material and workmanship are covered.

This warranty will only cover defects arising under normal usage.

This warranty is limited to repair or replacement by KisanKraft Limited or its manufacturers at the premises of Authorized Dealers, of such parts as appear to KisanKraft or its manufacturers, upon inspection, to be defective in material and/or workmanship. KisanKraft or its manufacturers make no warranty with respect to trade accessories not manufactured or sold by them.

What is not covered: The warranty shall become null and void and neither KisanKraft Limited nor any of its manufacturers, nor its authorized dealers assumes any responsibility, if the failure was caused by the following:

- (1) Operation of product with incorrect fuel or lubricants,
- (2) Incorrect usage of machine or misuse,
- (3) Lack of maintenance,
- (4) Negligence,
- (5) Accident or physical damage,
- (6) Repairs made by unauthorized parties and/or with unauthorized parts,
- (7) Improper set up, adjustments, tampering or altered products

This warranty is null & void, if you fail to register the warranty with KisanKraft by sending the KisanKraft Copy with dealer's stamp.

KisanKraft Limited (formerly known as KisanKraft Machine Tools P Ltd)

🌐: www.kisankraft.com ✉: info@kisankraft.com ☎: +91.80. 22178200

Cause	Remedy
2. Diesel oil filter and oil supply duct are blocked or gas leakage	Clean or evacuate the air
3. Injector parts are seized	Clean or grind parts and replace if necessary
B. Failure of lubrication system	
1. Insufficient engine oil in crank case causes damages of mechanical parts	Fill engine oil, repair damaged parts and replace if necessary
2. Bad lubrication of crank journal damages the bushing	Clean oil passage, repair damaged parts

Other Failures:

Cause	Remedy
A. Injector is seized often	
1. High temperature crash stop	Crash stop is not allowed.
2. Unclean fuel or damaged fuel filter.	Clean oil tank, replace fuel filter
B. Engine oil overflows from exhaust	
1. Piston or cylinder head is worn out	Check, repair and replace the piston or cylinder if necessary
2. Throttle duct is worn out	Check, repair and replace the throttle duct if necessary.
3. Piston ring is bonded or damaged	Clean or replace the piston ring
4. Excessive engine oil	Discharge engine oil until normal level is reached
C. Fluctuating rotary speed	
1. Gas leakage at the joint of oil supply pipe	Fasten the joint or replace gasket
2. Adjusting bolt on speed regulating spring is loosened.	Adjust and fasten
D. Black smoke in exhaust	
1. Overload	Reduce load
2. Improper power	Select proper power
3. Improper oil supply advance angle	Adjust as per relevant requirements

🌐: www.kisankraft.com ✉: info@kisankraft.com ☎: +91.80. 22178200

Insufficient Engine Power:

Cause	Remedy
A. Failure of oil passage system	
1. Oil passage is blocked, unsmooth oil supply	Check the oil passage
2. Bad oil supply of injection pump	Repair or replace the necessary parts
3. Failure of injector	Refer to "difficulty in starting"
B. Insufficient compression force	Refer to "difficulty in starting"
C. Air filler is blocked	Clean or replace filter element
D. Rotary speed is too low	Throttle up
E. Improper oil supply advance angle	Adjust as per the requirements
F. Improper clearance of air intake and exhaust valve.	Adjust as per the requirements
G. Parts of injection pump or injector is worn out or injection pressure is insufficient	Replace parts and adjust injection pressure.

Unstable working or discontinuous eruption noise

Cause	Remedy
A. Failure of fuel system	
1. Air mixing in fuel system	Evacuate the air
2. Bad fuel quality or water mixing in fuel	Check the fuel and replace it if necessary
3. Injector parts are jammed or excessive injection pressure	Check injector and adjust injection pressure
4. Needle valve parts of injector is worn out or parts are blocked by injector stem	Check the parts and replace if necessary.
B. Speed regulating system is seized	Check, repair or replace the regulating valve.

Self-Shutdown of Diesel Engine:

Cause	Remedy
A. Failure of fuel system	
1. Insufficient fuel in oil tank	Refill the fuel

Important: (1) Normal maintenance and adjustments to the product is the responsibility of the customer. (2) Normal wear and tear is not covered under warranty.(3) Rubber/plastic parts and consumables such as blades, clutch and clutch-bell, spark-plugs, nylon line, air-filters, fuel-filters, oil seals etc. are not covered under the warranty.

No Warranty On Electrical Motor / Electrical Parts / Battery Etc.

Incidental / Consequential Loss: KisanKraft Limited or its manufacturers will not be liable for general damages, including bodily injuries, or for incidental or consequential damages including, but not limited to, loss of use, loss of profits, loss of production, expense of substitute equipment or other commercial loss or damage.

Limitation of Liability: This limited warranty is in lieu of all other express warranties, obligations, or liabilities. Any implied warranties, obligations or liabilities, including, but not limited to, any implied warranty of merchantability shall be limited in duration to the applicable warranty period. Any action for breach of any warranties hereunder, including, but not limited to, any implied warranty of merchantability must be brought within the applicable warranty period.

Modifications of Warranty: No agent, representative, dealer, or employee of KisanKraft Limited or any of its manufacturers has the authority to increase or alter the obligations of this warranty.

Assignment / Transfer of warranty: The warranty cannot be assigned and shall not transfer if the product is resold by the first buyer. The above warranties are extended to the first end user (original purchaser), and no warranty is made, nor authorized to be made assignable on resale by the first end user.

What you must do to obtain limited warranty service: To obtain performance of any obligation under this warranty for failure during the applicable warranty period, deliver the defective product, to the nearest Authorized Dealer. KisanKraft Limited, its manufacturers and its dealers reserve the right to inspect the claimed defective part(s) to determine if the malfunction is the result of a defect covered by this warranty. Please note that the decision of KisanKraft Limited with respect to any warranty claim is final.

Receipt is required for availing warranty services

Jurisdiction: All disputes are subject to Bangalore court's jurisdiction.

Our Products	<ul style="list-style-type: none"> ◆Chainsaws◆Brush Cutters and Accessories◆Harvesters◆ ◆Engines and Water Pumps◆Hand Tools◆Garden Tools◆ ◆Cultivators and Accessories◆Sprayers and Accessories◆ ◆Transplanter and Post Hole Digger ◆Milking Machines◆
---------------------	--

This warranty is null & void, if you fail to register the warranty with KisanKraft by sending the KisanKraft Copy with dealer's stamp.

KisanKraft Limited (formerly known as KisanKraft Machine Tools P Ltd)

Before Getting Started

Please read this manual carefully before operating the machine. This manual guides how to operate the air-cooled diesel engine correctly, as well as warnings. This manual should be considered as the permanent part of the engine and should be for future reference. This engine will meet your requirement if you operate it according to the manual instruction.

Safety Instructions



Indicates that serious personal injury even death can result if the instructions are not followed.



Indicates that serious personal injury even death can result if the instructions are not followed.



Indicates that serious personal injury even death can result if the instructions are not followed.

NOTE Indicates that you must give special attention while operating the engine. Otherwise the engine performance will be decreased or even a fault may result. Be sure to follow the **Note**.

1. To prevent the fire, please pay attention to the following:
 - If gasoline is filled into the engine, fire may result. So identify the fuel type and model before refilling.
 - Be sure to stop the engine before refilling.
 - Wipe off the oil which has overflowed or spilled.
 - Keep the engine far away from other flammable oils and goods.
2. Be careful when using the battery:
 - The battery will exhaust hydrogen while charging. Do charge the battery at a well ventilated place. Meanwhile, flame and spark are not allowed while charging.
 - The electrolyte is heavily acidic solution, be sure skin and eyes do not come in contact with that. Rinse with water immediately if happens so.
3. The exhaust is poisonous, pay attention to the following:
 - The exhaust is harmful to health, do not run the engine at the confined rooms or less ventilated places. If you have to run the engine indoors, be sure there is good ventilation equipment.
4. Danger from moving parts:
 - Do not touch the moving parts while the engine is running, meanwhile, when the engine is linked to the load, please cover the coupler and belt etc. parts which have potential danger before running.
5. Stay away from hot parts:

Troubleshooting

Difficulty in starting or failure to start:

Cause	Remedy
A. Extremely cold weather	Pour in 3-5g engine oil in air intake pipe or spray hot water at the top of the cylinder head.
B. Failure of fuel system	
1. Fuel is frozen	Replace the fuel, apply proper fuel type.
2. Water in fuel	Clean oil tank and replace fuel
3. Failure of injector	Adjust pressure or clean up carbon deposit, grind or replace parts
4. Injector doesn't work or bad fuel supply of oil pump	Fasten type T bolt of oil supply pipe, evacuate air in the pipe.
C. Insufficient compression force	
1. Nuts of cylinder head is loosened or cylinder gasket is damaged	Fasten nuts or replace gasket
2. Piston ring, piston, or cylinder liner is worn out.	Repair or replace the part whichever is necessary.
3. Piston ring is banded or broken	Clean or replace the piston ring
4. Bad sealing of throttle and throttle seat causes gas leakage.	Grind throttle.
5. Improper clearance of air intake and exhaust valve.	Adjust as per relevant requirements
6. Throttle stem is seized in duct	Remove throttle and clean it
7. Too much drop of compression ratio even after adjusting throttle seat several times.	Replace throttle seat.
D. Improper oil supply advance angle	Adjust as per relevant requirements
E. Viscosity of engine oil is too large	Fill engine oil of right type and right grade.

Intervals Items	Every day	20 hrs	50 hrs	100 hrs	200 hrs	500 hrs	1000 hrs
Check oil leakage	☐						
Replace air cleaner						☐	
Clean fuel oil cleaner				☐		☐	☐ (Replace)
Check nozzle						☐	
Check fuel injection pump						☐	
Adjust the clearance of the intake/ exhaust valve						☐	
Check the intake/ exhaust valve							☐
Replace the piston ring							☐
Check the electrolyte	Check it every month, refill the distilled water if necessary						

Long Term Storage

Prepare the following items before long term storage:

1. Run the engine 5 minutes at low speed.
2. Drain out the engine oil while the engine is warm and refill with fresh engine oil.
3. Remove the filler screw plug on the cylinder head case and refill about 2cc engine oil.
4. Press down the decompression lever and pull the recoil starter 2-3 times (do not start the engine).
5. Return the decompression lever back to the decompression position, and pull the recoil starter slowly until you feel the resistance (at this point, both intake/exhaust valves are closed to prevent the engine from rust.)
6. Clean off the dirt on the engine surface, then store the engine at a dry place.

- The muffler and the engine body will be hot during running or just after running. Do not touch these parts.
6. Other safety information:
- Do not operate the engine after consuming alcohol, drugs or any other medicines which cause drowsiness.
 - Be sure that the surrounding is safe before starting the engine.
 - Wear proper clothing and anti-skid shoes.

Technical Specifications

Model		KK-DEV-370F	KK-DEV-378F	KK-DEV 386F	
Type		Single cylinder, 4-stroke, vertical, air-cooled, direct-injection diesel engine.			
Combustion system		Direct injection combustion			
Piston displacement (L)		0.211	0.296	0.406	
Cooling system		Forced air-cooled			
Starting system		Recoil starter			
Rated power	Max. kW(PS)	3.1(4.2)	4.4(6.0)	6.6(9.0)	
	Continue, kW(PS)	2.8(3.8)	4 (6.0)	6.3 (8.6)	
Output shaft	Rated speed (rpm)	3600/1800			
Fuel oil	Spray pressure kgf/cm ² (MPa)	200(19.6)			
	Applicable lube oil	Light diesel			
	Fuel tank capacity(L)	2.5	3.5	5.5	
Lubricating system	Lube oil capacity	Full (L)	0.75	1.1	1.65
	Effective (L)		0.25	0.4	0.6

Note: The specifications may vary due to the development of the product. The figures included in this book may look different with the actual products.

Assembly

NOTE: Too much shock during the running will damage the engine and the load, be sure to set the engine tightly.

1. Fix the engine base seat tightly to prevent the engine from offset and shock.
2. Be sure the PTO shaft centers are in line.



If the pulley is too tight, accident may result. Please select the suitable size pulley

3. If the pulley drives the engine, the pulley size must be in accordance with the load speed. The diameter of the pulley can be calculated by the following format:

$$\text{Engine side pulley} = \frac{\text{Load side pulley} \times \text{load speed}}{\text{Engine speed (rated speed)}}$$

4. Make sure that the bearing hole of the pulley, keyway size are in conformance with the PTO shaft. Otherwise accidents may occur. Tighten the PTO shaft bolt properly. Do select the appropriate diameter pulley, if the engine continually exhaust black smoke during operation.
5. Be sure the pulley tension is correct. If the belt is too tight, it will be difficult to start, furthermore the belt will worn quickly and the PTO shaft will be bent, so accidents may result.

The torsion of the pulley: Press the central part of the pulley surface. Every 100mm of the pulley, deflection is about 1.6mm (For example: the clearance of the pulley is 500mm, the deflection will be 8mm).

Operation

The first 20hrs is the break-in period of the engine, the operator must obey the following:

1. **Warm up the engine 5 minutes after the initial starting:** Run the engine at low speed and zero load before the engine becomes warm. Do not run the engine at high speed.
2. **Do not run the engine with overload:** It is recommended to run the engine at 3000rpm with 50% load in break-in period.
3. **Replace the engine oil on time:**

Replace the engine oil while the engine is warm after 20-hours of operation, after draining the old engine oil completely.

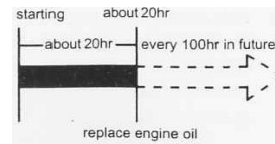

Selection and Usage of the Fuel Oil:

Selection: Please use the light diesel most applicable for the performance of the engine
Diesel usage:

Stopping the Engine

1. Set the governor lever to low speed position, then run the engine at no load for 5 minutes.
2. Set the governor lever to the "STOP" position. Do not stop the engine with the decompression lever.
3. Set the fuel cock to "OFF" position.
4. Pull the recoil starter handle slowly, until you feel resistance. (At this point, the decompression just begins and intake/exhaust valves are both closed, thus the cylinder can be prevented from rust.)
5. Concerning the electric starting engine, directly turn the starting key to "CLOSE" position.

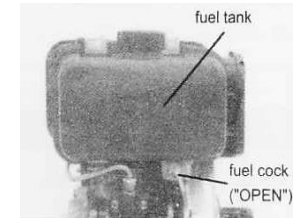
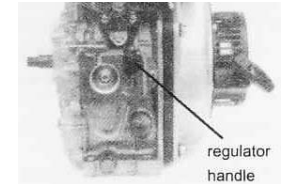

Prepare For The Next Operation:

1. Fill diesel in to the tank.
2. Check all the bolts and nuts. Screw on them if necessary.
3. Clean the dirt on the surface of the engine body.

Maintenance

Periodical check and maintenance are very important for maintaining the performance and life of the engine. Follow the table given below:

Intervals Items	Every day	20 hrs	50 hrs	100 hrs	200 hrs	500 hrs	1000 hrs
Check all the bolts & nuts	☐						
Check and refill engine oil	☐						
Replace engine oil		☐ (First time)	☐ (Second time)				
Clean or replace engine oil cleaner		☐ (clean)	☐ (clean)				☐ (Replace)

Run the Engine

⚠ WARNING

- To prevent the exhaust toxicities, be sure to run the engine at ventilated place.
 - To prevent personal injury, avoid hands, clothes or any other body parts from involving into the output shaft, pulley and V pulley etc. moving parts.
 - Check the moving parts and the surrounding parts after stopping the engine. Be sure that there is no tool or cloth inside the engine body.
 - The muffler is very hot during operation or immediately after operation. So, never touch the muffler.
 - To prevent any injuries, avoid contact with the air cleaner as it will suck the surrounding airflow during operation.
- Warm up the engine for 5 minutes.
 - If the engine is very hot, set the governor lever to the expected position.
NOTE: Be sure to regulate the engine speed with the governor lever.
Do not screw off the adjusting bolt and the fuel adjusting bolts, otherwise abnormal speed and output may result.

- If the engine continually exhaust black smoke during operation, which indicates that the engine is running with overload, do adjust the engine pulley and the load pulley

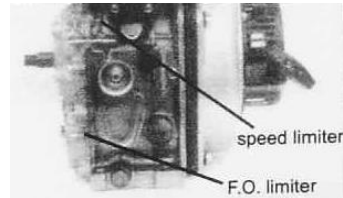

Please Pay Attention To The Following Items While Running:

- Whether there is abnormal vibration and sound.
- Whether the exhaust is normal.
- Whether the engine continually exhausts white smoke or black smoke.
- Be sure to shut off the engine when any abnormal phenomenon arouses, contact the dealer immediately.

- If diesel is mixed with water and dirt, then abnormal running will result. Seal the diesel in clean drums and store the drums in a dry place away from rain and dirt.
- If diesel has been stored for several hours, the water and dirt will get deposited at the bottom of the drum. You can pump the upper portion of the diesel for usage.

Refueling the diesel:

⚠ DANGER

- If gasoline is filled into the engine, fire may result. So identify the fuel type and model before refilling.
- Be sure to stop the engine before refilling.
- Wipe off the oil which has overflowed or spilled.
- Keep the engine far away from other flammable oils and goods.
- Water and foreign matter will be sunk into the lower portion of the barrel. Put the suction pipe into the barrel at a place till half the depth of the barrel, pump clean oil on the upper position in the barrel.

FUEL OIL CAPACITY

⚠ CAUTION

Do not let fuel level be higher than Red Mark.

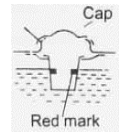

Model	Fuel Oil Capacity
170F	2.5
178F	3.5
186F	5.5

Selection and Usage of the Engine Oil

Selection of the Engine oil: It is very important to select the right oil. If you use improper diesel, the piston rings will adhere together, the piston may burn out and the cylinder head gasket will wear out quickly as well as bearings and other moving parts, reducing the engine life.

The viscosity of the engine oil is depended on the ambient temperature:

Ambient temperature	Above 20°C	10-20°C	Below 10°C
	SAE 30	SAE 20	SAE 10W-30

Check and Refill the Engine Oil:

Note:

- Check the engine oil level with the engine kept on a flat surface and the engine stopped.
 - Check the engine oil level before tightening the filter cap.
- a) Be sure to check the engine oil level before starting the engine.
- Check whether the engine oil level is between the upper level and the lower level.
 - Wipe off the spilled oil.
 - Screw on the oil filler cap after checking.
- b) The engine oil level cannot go beyond the upper level.

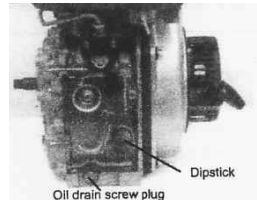
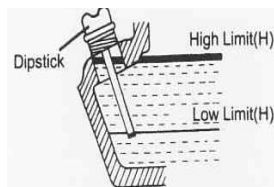

Replace the Air Cleaner:

1. Screw off the wing nut and remove the air cleaner cover. If the output power of the engine is not sufficient, the exhaust color will be abnormal, then it is necessary to replace the element.
2. Reassemble the air cleaner cover and screw on the wing nut after replacement.

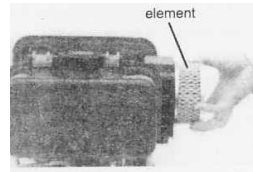

The Exhaust Direction:

To prevent the exhaust from flowing into the air cleaner, assemble an exhaust syphon on the case of the muffler.

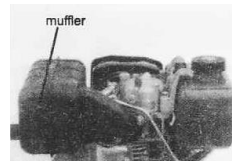

Procedures:

1. Remove the electric starting switch body from the standard panel, then reassemble it to the installation panel of the cylinder head case.
2. Screw off the two bolts from the cylinder head case.
3. Clip the reassembled panel with the long washer, then tight it with hexagonal bolts.
Note: If the wire harness touch the muffler or the PTO shaft, fire may result.
4. Set the earth terminal of the harness with M6 bolt.

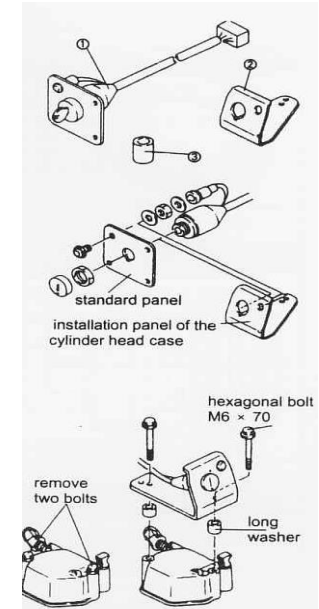

Electric Wiring Diagram

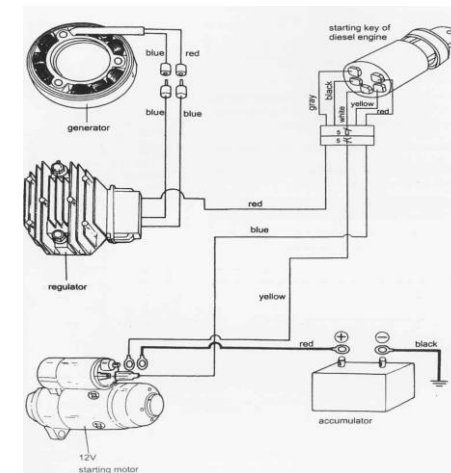

Electric Starting

Starting Method:

(Pre-starting check is same as that of manual starting.)

- Open the fuel cock.
- Turn the governor lever to "STARTING" position.
- Turn the electric starting key clockwise to "STARTING" position.
- Release the electric key after the engine is started.
- If the engine could not start even after the running the starting motor for 10seconds, start it again after 15 seconds. (Running the starting motor for long time will cause the battery power, even burn out the motor.)

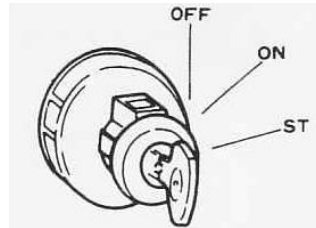
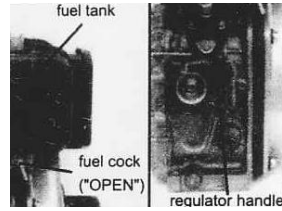

Maintenance of the Battery:

Check the battery every month. Refill the distilled water until the upper level if the electrolyte dropped to the lower level.

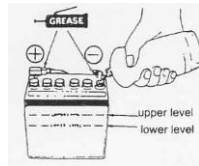

Assembling the Electric Starting Switch:

If the electric starting switch locates on the top of the cylinder head case, assemble it with the following parts according to the specified procedures.

SI No.	Specification	Quantity
1.	Electric starting switch body	1
2.	Electric starting switch panel	1
3.	Long washer	2
4.	Hexagonal bolt M6X70	2

Note: Prevent the water from accumulating on the exhaust syphon from flowing into the muffler.

Starting the Engine

Manual Starting:

Start the engine according to the following procedures:

- Open the fuel cock
- Turn the governor lever to "STARTING" position.
- Hold the recoil starter handle

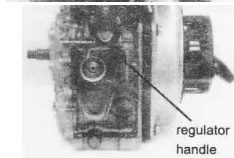
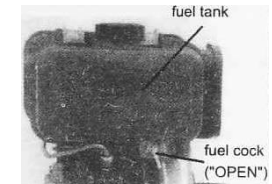

- Pull the starter handle until you feel the resistance, then return the handle slowly



- Press the decompression lever to "Non-compression" position. The lever will



- Hold the recoil starter handle with two hands and pull it hardly

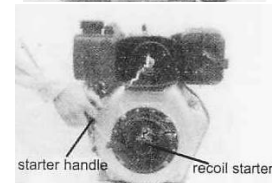

- d) It is difficult to start the engine during cold weather. Remove the rubber plug on the cylinder head and fill about 2 cc engine oil before starting



Note: Always screw on the rubber plug on the cylinder head except while filling, to prevent the rain and dirt from flowing into the engine body

