

**Important:** (1) Normal maintenance and adjustments to the product is the responsibility of the customer. (2) Normal wear and tear is not covered under warranty. (3) Rubber/plastic parts and consumables such as blades, clutch and clutch-bell, spark-plugs, nylon line, air-filters, fuel-filters, oil seals etc. are not covered under the warranty.

**No Warranty On Electrical Motor / Electrical Parts Etc.**

**Incidental / Consequential Loss:** KisanKraft Limited or its manufacturers will not be liable for general damages, including bodily injuries, or for incidental or consequential damages including, but not limited to, loss of use, loss of profits, loss of production, expense of substitute equipment or other commercial loss or damage.

**Limitation of Liability:** This limited warranty is in lieu of all other express warranties, obligations, or liabilities. Any implied warranties, obligations or liabilities, including, but not limited to, any implied warranty of merchantability shall be limited in duration to the applicable warranty period. Any action for breach of any warranty hereunder, including, but not limited to, any implied warranty of merchantability must be brought within the applicable warranty period.

**Modifications of Warranty:** No agent, representative, dealer, or employee of KisanKraft Limited or any of its manufacturers has the authority to increase or alter the obligations of this warranty.

**Assignment / Transfer of warranty:** The warranty cannot be assigned and shall not transfer if the product is resold by the first buyer. The above warranties are extended to the first end user (original purchaser), and no warranty is made, nor authorized to be made assignable on resale by the first end user.

**What you must do to obtain limited warranty service:** To obtain performance of any obligation under this warranty for failure during the applicable warranty period, deliver the defective product, to the nearest Authorized Dealer. KisanKraft Limited, its manufacturers and its dealers reserve the right to inspect the claimed defective part(s) to determine if the malfunction is the result of a defect covered by this warranty. Please note that the decision of KisanKraft Ltd with respect to any warranty claim is final.

**Receipt is required for availing warranty services**

**Jurisdiction:** All disputes are subject to Bangalore court's jurisdiction.

<b>Our Products</b>	<ul style="list-style-type: none"> <li>◆Chainsaws◆Brush Cutters and Accessories◆Harvesters◆</li> <li>◆Engines and Water Pumps◆Hand Tools◆Garden Tools◆</li> <li>◆Cultivators and Accessories◆Sprayers and Accessories◆</li> <li>◆Transplanter and Post Hole Digger ◆Milking Machines◆</li> </ul>
---------------------	--

**This warranty is null & void, if you fail to register the warranty with KisanKraft by sending the KisanKraft Copy with dealer's stamp.**

**KisanKraft Limited** (formerly known as KisanKraft Machine Tools P Ltd)

🌐: www.kisankraft.com    ✉: info@kisankraft.com    ☎: +91.80.22178200

Product	<b>Agricultural Reaper (Baffle Type) &amp; Weeder</b>	KisanKraft™ Invoice Date	
Brand	<b>KisanKraft</b>	KisanKraft™ Invoice No.	
Model	<input type="checkbox"/> KK-BC-7640 <input type="checkbox"/> KK-BC-8640 <input type="checkbox"/> KK-BC2-8647 <input type="checkbox"/> KK-BC2-8665 <input type="checkbox"/> KK-BC4-8634 <input type="checkbox"/> KK-BC4-8637 <input type="checkbox"/> KK-SBC-4302 <input type="checkbox"/> KK-SBC-3404 <input type="checkbox"/> KK-TC2-8641		
<b>WARRANTY PERIOD</b>	<b>6 MONTHS</b>	FOR THE SPECIFIED PERIOD FROM THE DATE OF SALE OR DELIVERY WHICHEVER IS EARLIER.	
Dealer's Invoice Date		Dealer's Invoice No.	
Buyer's Info (Name, Address, Phone, etc.):		Dealer's Stamp (Address, Phone, TIN, etc.):	
Buyer's Sign		Dealer's Sign	

**What is covered:** KisanKraft Limited and its manufacturers warrant this product to be free from defects in material or workmanship. All parts defective in material and workmanship are covered.

This warranty will only cover defects arising under normal usage.

This warranty is limited to repair or replacement by KisanKraft Limited or its manufacturers at the premises of Authorized Dealers, of such parts as appear to KisanKraft or its manufacturers, upon inspection, to be defective in material and/or workmanship. KisanKraft or its manufacturers make no warranty with respect to trade accessories not manufactured or sold by them.

**What is not covered:** The *warranty shall become null and void* and neither KisanKraft Limited nor any of its manufacturers, nor its authorized dealers assumes any responsibility, if the failure was caused by the following:

- (1) Operation of product with incorrect fuel or lubricants,
- (2) Incorrect usage of machine or misuse,
- (3) Lack of maintenance,
- (4) Negligence,
- (5) Accident or physical damage,
- (6) Repairs made by unauthorized parties and/or with unauthorized parts,
- (7) Improper set up, adjustments, tampering or altered products

**This warranty is null & void, if you fail to register the warranty with KisanKraft by sending the KisanKraft Copy with dealer's stamp.**

**KisanKraft Limited** (formerly known as KisanKraft Machine Tools P Ltd)

🌐: www.kisankraft.com    ✉: info@kisankraft.com    ☎: +91.80.22178200

**Important:** (1) Normal maintenance and adjustments to the product is the responsibility of the customer. (2) Normal wear and tear is not covered under warranty (3) Rubber/plastic parts and consumables such as blades, clutch and clutch-bell, spark-plugs, nylon line, air-filters, fuel-filters, oil seals etc. are not covered under the warranty.

**No Warranty On Electrical Motor / Electrical Parts Etc.**

**Incidental / Consequential Loss:** KisanKraft Limited or its manufacturers will not be liable for general damages, including bodily injuries, or for incidental or consequential damages including, but not limited to, loss of use, loss of profits, loss of production, expense of substitute equipment or other commercial loss or damage.

**Limitation of Liability:** This limited warranty is in lieu of all other express warranties, obligations, or liabilities. Any implied warranties, obligations or liabilities, including, but not limited to, any implied warranty of merchantability shall be limited in duration to the applicable warranty period. Any action for breach of any warranties hereunder, including, but not limited to, any implied warranty of merchantability must be brought within the applicable warranty period.

**Modifications of Warranty:** No agent, representative, dealer, or employee of KisanKraft Limited or any of its manufacturers has the authority to increase or alter the obligations of this warranty.

**Assignment / Transfer of warranty:** The warranty cannot be assigned and shall not transfer if the product is resold by the first buyer. The above warranties are extended to the first end user (original purchaser), and no warranty is made, nor authorized to be made assignable on resale by the first end user.

**What you must do to obtain limited warranty service:** To obtain performance of any obligation under this warranty for failure during the applicable warranty period, deliver the defective product, to the nearest Authorized Dealer. KisanKraft Limited, its manufacturers and its dealers reserve the right to inspect the claimed defective part(s) to determine if the malfunction is the result of a defect covered by this warranty. Please note that the decision of KisanKraft Ltd with respect to any warranty claim is final.

**Receipt is required for availing warranty services**

**Jurisdiction:** All disputes are subject to Bangalore court's jurisdiction.

<b>Our Products</b>	<ul style="list-style-type: none"> <li>◆Chainsaws◆Brush Cutters and Accessories◆Harvesters◆</li> <li>◆Engines and Water Pumps◆Hand Tools◆Garden Tools◆</li> <li>◆Cultivators and Accessories◆Sprayers and Accessories◆</li> <li>◆Transplanter and Post Hole Digger ◆Milking Machines◆</li> </ul>
---------------------	--

**This warranty is null & void, if you fail to register the warranty with KisanKraft by sending the KisanKraft Copy with dealer's stamp.**

**KisanKraft Limited** (formerly known as KisanKraft Machine Tools P Ltd)

🌐: [www.kisankraft.com](http://www.kisankraft.com)    ✉: [info@kisankraft.com](mailto:info@kisankraft.com)    ☎: +91.80.22178200

Product	<b>Agricultural Reaper (Baffle Type) &amp; Weeder</b>	KisanKraft Invoice Date	
Brand	<b>KisanKraft</b>	KisanKraft Invoice No.	
Model	<input type="checkbox"/> KK-BC-7640 <input type="checkbox"/> KK-BC-8640 <input type="checkbox"/> KK-BC2-8647 <input type="checkbox"/> KK-BC2-8665 <input type="checkbox"/> KK-BC4-8634 <input type="checkbox"/> KK-BC4-8637 <input type="checkbox"/> KK-SBC-4302 <input type="checkbox"/> KK-SBC-3404 <input type="checkbox"/> KK-TC2-8641		
<b>WARRANTY PERIOD</b>	<b>6 MONTHS</b>	FOR THE SPECIFIED PERIOD FROM THE DATE OF SALE OR DELIVERY WHICHEVER IS EARLIER.	
Dealer's Invoice Date		Dealer's Invoice No.	
Buyer's Info (Name, Address, Phone, etc.):		Dealer's Stamp (Address, Phone, TIN, etc.):	
Buyer's Sign		Dealer's Sign	

**What is covered:** KisanKraft Limited and its manufacturers warrant this product to be free from defects in material or workmanship. All parts defective in material and workmanship are covered.

This warranty will only cover defects arising under normal usage.

This warranty is limited to repair or replacement by KisanKraft Limited or its manufacturers at the premises of Authorized Dealers, of such parts as appear to KisanKraft or its manufacturers, upon inspection, to be defective in material and/or workmanship. KisanKraft or its manufacturers make no warranty with respect to trade accessories not manufactured or sold by them.

**What is not covered:** The *warranty shall become null and void* and neither KisanKraft Limited nor any of its manufacturers, nor its authorized dealers assumes any responsibility, if the failure was caused by the following:

- (1) Operation of product with incorrect fuel or lubricants,
- (2) Incorrect usage of machine or misuse,
- (3) Lack of maintenance,
- (4) Negligence,
- (5) Accident or physical damage,
- (6) Repairs made by unauthorized parties and/or with unauthorized parts,
- (7) Improper set up, adjustments, tampering or altered products

**This warranty is null & void, if you fail to register the warranty with KisanKraft by sending the KisanKraft Copy with dealer's stamp.**

**KisanKraft Limited** (formerly known as KisanKraft Machine Tools P Ltd)

🌐: [www.kisankraft.com](http://www.kisankraft.com)    ✉: [info@kisankraft.com](mailto:info@kisankraft.com)    ☎: +91.80. 22178200



Wide Range of Products for Every Need



For more information give **MISSED CALL: 07676065555**



Many of our products have BIS: ISI certification.



# Operation Manual



## KisanKraft Limited

(Formerly known as KisanKraft Machine Tools Pvt Ltd)

Sri Huchhanna Tower, #4, 1<sup>st</sup> Main, 7-A Cross, Maruthi Layout, Dasarahalli,  
 HAF Post, Hebbal, Bangalore 560024, Karnataka, INDIA

- ◆ Bangalore (HO) ◆ Ahmedabad ◆ Bhopal ◆ Bhubaneswar ◆ Coimbatore ◆
- ◆ Guwahati ◆ Patna ◆ Hinudpur ◆ Hubli ◆ Hyderabad ◆ Jaipur ◆ Karnal ◆
- ◆ Kolkata ◆ Lucknow ◆ Jammu ◆ Pune ◆ Raipur ◆ Shimla ◆

**CONTENTS**

**BEFORE GETTING STARTED..... 7**

**SAFETY INSTRUCTIONS..... 8**

**GENERAL DESCRIPTION .....12**

**ASSEMBLY .....13**

**CUTTING WITH A NYLON HEAD .....14**

**OPERATION.....18**

**MAINTENANCE .....22**

**TRANSPORT AND STORAGE.....24**

**TROUBLESHOOTING .....25**

**TECHNICAL SPECIFICATIONS .....26**

**ENGINE-DIAGRAM & PARTS LIST-KK-BC2-8665 .....27**

**BODY PARTS-KK-BC-8665 .....29**

**ENGINE-PARTS DIAGRAM & LIST-KK-BC4-8634/8637.....34**

**BODY PARTS DIAGRAM & PARTS LIST-KK-BC4-8634/8637 .....37**

**ENGINE- DIAGRAM & PARTS LIST-KK-BC-7640/8640/8647 .....39**

**BODY PARTS DIAGRAM & LIST-KK-BC-7640/8640/8647 .....41**

**ENGINE-PARTS DIAGRAM & LIST-KK-SBC-4302 .....43**

**BODY PARTS DIAGRAM & LIST-KK-SBC-4302 .....45**

**PETROL ENGINE – OPERATION MANUAL .....48**

KisanKraft has a large range of products to serve the farmers. A list of our products is given below:

<p><b>Brush Cutters and Accessories</b></p> <ul style="list-style-type: none"> <li>Brush Cutter/Power Weeder</li> <li>Backpack Brush Cutter</li> <li>Tea Pruner</li> <li>Pole pruner with Engine</li> <li>Reaper Attachment</li> <li>Blades-Circular</li> <li>Blades (2 &amp; 3 points)</li> <li>Baffle</li> <li>Nylon Rope</li> <li>Tap &amp; Go</li> </ul> <p><b>Chainsaws</b></p> <ul style="list-style-type: none"> <li>Petrol Chainsaw</li> <li>Electric Chainsaw</li> <li>Chain Sharpening Machine</li> </ul> <p><b>Engines and Water Pumps</b></p> <ul style="list-style-type: none"> <li>Engine –Diesel-(Horizontal)</li> <li>Engine –Diesel(Vertical)</li> <li>Engine-Kerosene</li> <li>Water Pump with Petrol Engine</li> <li>Water Pump with Kerosene Engine</li> <li>Water Pump with Diesel Engine</li> </ul> <p><b>Hand Tools</b></p> <ul style="list-style-type: none"> <li>Secateurs</li> <li>Folding Saw</li> <li>Garden Rake</li> <li>Garden Shovel</li> <li>Hedge Shear</li> <li>Lopper</li> <li>Telescopic Hedge Shear</li> <li>Telescopic Lopping Shear</li> <li>Tree Pruner</li> <li>Telescopic Steel Pipe &amp; Fruit Picker Bag</li> <li>Sheep Shear</li> </ul> <p><b>Garden Tools</b></p> <ul style="list-style-type: none"> <li>Electric Pressure Washer</li> <li>Hedge Trimmer</li> <li>Lawn Mower (Electric, Petrol &amp; Manual)</li> <li>Leaf Blower</li> </ul>	<p><b>Cultivators and Accessories</b></p> <ul style="list-style-type: none"> <li>Petrol and Diesel</li> </ul> <p><b>Sprayers and Accessories</b></p> <ul style="list-style-type: none"> <li>Battery Sprayer</li> <li>Portable Power Sprayer</li> <li>Trolley Sprayer</li> <li>Manual Knapsack Sprayer</li> <li>Manual Pressure Sprayer</li> <li>Rose Cans</li> <li>Hose Crimping Machine</li> <li>HTP Sprayer</li> <li>HTP Delivery Hose</li> <li>HTP Hose Reel</li> <li>HTP Stand</li> <li>HTP Gun / Lance(Brass Rod)</li> <li>Knapsack Power Sprayer</li> <li>Mister / Duster / Granuel Spreader</li> <li>HTP Sprayer Set with Diesel Engine</li> <li>HTP Sprayer Set with Kerosene Engine</li> <li>Fogging Machine</li> </ul> <p><b>Milking Machine</b></p> <ul style="list-style-type: none"> <li>Wood Shredder</li> <li>Fodder Ensiling Chaff Cutter</li> <li>Fodder Grinder Chaff Cutter</li> <li>Fodder Mini Chaff Cutter</li> </ul> <p><b>Harvester</b></p> <ul style="list-style-type: none"> <li>Maize Sheller</li> <li>Maize Sheller + Dehusker</li> <li>Maize Combine Harvester</li> <li>Onion Digger Carlotti Italy</li> <li>Tea Leaf Harvester</li> <li>Sugarcane Combine Harvester</li> <li>Sugarcane Leaf Stripper</li> </ul> <p><b>Transplanter and Post Hole Digger</b></p> <ul style="list-style-type: none"> <li>Paddy Transplanter (2 &amp; 8 Rows)</li> <li>Transplanter-Vegetable &amp; Tobacco</li> <li>Post Hole Digger(4" to 14" Augers)</li> </ul>
--	---

**Abnormal Situations during Operation:**

Situations	Causes	Remedy
Rotating speed cannot be increased; insufficient power	Throttle is close. The ventilation of the muffler is not smooth. Moving members are worn. The ignition energy is low. The valve clearance is excessive. Carbon is deposited on the cylinder head.	Open the throttle. Replace the muffler. Inspect and replace them. Replace the igniter or the flywheel. Adjust or replace relevant parts. Remove the deposited carbon.
Spitting during operation	Blocked oil path of the carburetor Excessive or insufficient clearance of the spark plug	Replace the carburetor. Adjust the clearance.
Abnormal sound	Incorrect clearance of the throttle Damaged cam teeth	Replace relevant parts. Replace the cam shaft.
Oil leakage of carburetor	Failure of the non-return valve on fuel tank cap	Replace the non-return vent valve of the fuel tank cap.
	Damaged sealing elements of carburetor	Replace them.

Contact the dealer if the gasoline engine still has problems after inspection and repair based on the methods above.

Product	<b>Agricultural Reaper (Baffle Type) &amp; Weeder</b>	KisanKraft™ Invoice Date	
Brand	<b>KisanKraft</b>	KisanKraft™ Invoice No.	
Model	<input type="checkbox"/> KK-BC-7640 <input type="checkbox"/> KK-BC-8640 <input type="checkbox"/> KK-BC2-8647 <input type="checkbox"/> KK-BC2-8665 <input type="checkbox"/> KK-BC4-8634 <input type="checkbox"/> KK-BC4-8637 <input type="checkbox"/> KK-SBC-4302 <input type="checkbox"/> KK-SBC-3404 <input type="checkbox"/> KK-TC2-8641		
<b>WARRANTY PERIOD</b>	<b>6 MONTHS</b>	FOR THE SPECIFIED PERIOD FROM THE DATE OF SALE OR DELIVERY WHICHEVER IS EARLIER.	
Dealer's Invoice Date		Dealer's Invoice No.	
Buyer's Info (Name, Address, Phone, etc.):		Dealer's Stamp (Address, Phone, TIN, etc.):	
Buyer's Sign		Dealer's Sign	

**What is covered:** KisanKraft Limited and its manufacturers warrant this product to be free from defects in material or workmanship. All parts defective in material and workmanship are covered.

This warranty will only cover defects arising under normal usage.

This warranty is limited to repair or replacement by KisanKraft Limited or its manufacturers at the premises of Authorized Dealers, of such parts as appear to KisanKraft or its manufacturers, upon inspection, to be defective in material and/or workmanship. KisanKraft or its manufacturers make no warranty with respect to trade accessories not manufactured or sold by them.

**What is not covered:** The *warranty shall become null and void* and neither KisanKraft Limited nor any of its manufacturers, nor its authorized dealers assumes any responsibility, if the failure was caused by the following:

- (1) Operation of product with incorrect fuel or lubricants,
- (2) Incorrect usage of machine or misuse,
- (3) Lack of maintenance,
- (4) Negligence,
- (5) Accident or physical damage,
- (6) Repairs made by unauthorized parties and/or with unauthorized parts,
- (7) Improper set up, adjustments, tampering or altered products.

**This warranty is null & void, if you fail to register the warranty with KisanKraft by sending the KisanKraft Copy with dealer's stamp.**

**KisanKraft Limited** (formerly known as KisanKraft Machine Tools P Ltd)

**Important:** (1) Normal maintenance and adjustments to the product is the responsibility of the customer. (2) Normal wear and tear is not covered under warranty. (3) Rubber/plastic parts and consumables such as blades, clutch and clutch-bell, spark-plugs, nylon line, air-filters, fuel-filters, oil seals etc. are not covered under the warranty.

**No Warranty On Electrical Motor / Electrical Parts Etc.**

**Incidental / Consequential Loss:** KisanKraft Limited or its manufacturers will not be liable for general damages, including bodily injuries, or for incidental or consequential damages including, but not limited to, loss of use, loss of profits, loss of production, expense of substitute equipment or other commercial loss or damage.

**Limitation of Liability:** This limited warranty is in lieu of all other express warranties, obligations, or liabilities. Any implied warranties, obligations or liabilities, including, but not limited to, any implied warranty of merchantability shall be limited in duration to the applicable warranty period. Any action for breach of any warranty hereunder, including, but not limited to, any implied warranty of merchantability must be brought within the applicable warranty period.

**Modifications of Warranty:** No agent, representative, dealer, or employee of KisanKraft Limited or any of its manufacturers has the authority to increase or alter the obligations of this warranty.

**Assignment / Transfer of warranty:** The warranty cannot be assigned and shall not transfer if the product is resold by the first buyer. The above warranties are extended to the first end user (original purchaser), and no warranty is made, nor authorized to be made assignable on resale by the first end user.

**What you must do to obtain limited warranty service:** To obtain performance of any obligation under this warranty for failure during the applicable warranty period, deliver the defective product, to the nearest Authorized Dealer. KisanKraft Limited, its manufacturers and its dealers reserve the right to inspect the claimed defective part(s) to determine if the malfunction is the result of a defect covered by this warranty. Please note that the decision of KisanKraft Ltd with respect to any warranty claim is final.

**Receipt is required for availing warranty services**

**Jurisdiction:** All disputes are subject to Bangalore court's jurisdiction.

<b>Our Products</b>	<ul style="list-style-type: none"> <li>◆Chainsaws◆Brush Cutters and Accessories◆Harvesters◆</li> <li>◆Engines and Water Pumps◆Hand Tools◆Garden Tools◆</li> <li>◆Cultivators and Accessories◆Sprayers and Accessories◆</li> <li>◆Transplanter and Post Hole Digger ◆Milking Machines◆</li> </ul>
---------------------	--

**This warranty is null & void, if you fail to register the warranty with KisanKraft by sending the KisanKraft Copy with dealer's stamp.**

**KisanKraft Limited** (formerly known as KisanKraft Machine Tools P Ltd)

**NOTE:** If the unit is left over without draining fuel, impurities in the fuel could clog the fuel passages such as the carburetor, fuel filter, or others, and cause engine troubles. Make sure to drain the fuel when storing the unit for a long period of time.

▲ Sufficient care must be taken not to use fires at the vicinity when handling the fuel.

**TROUBLESHOOTING**

**Startup Failure or Difficulty in Startup**

Situations		Causes	Remedy
The spark plug is fireless.	Spark plug	Carbon deposition on the spark plug. Excessive or insufficient clearance of the spark plug. Damaged insulation of the spark plug.	Remove the deposited carbon. Adjust it to 0.6~0.7mm Replace the spark plug
	Others	Damaged igniter Weak magnetic force of the flywheel	Replace the igniter Replace the flywheel
The spark plug cannot generate spark.	Good compression	Too much fuel adsorbed in the cylinder Poor fuel, containing water, too dirty	Screw out the spark plug, dry it and screw it in again. Replace the fuel.
	The carburetor oil pump has (not) the ability to pump oil.	Blocked internal oil path	Clean or replace the carburetor.
	Normal oil supply but poor compression	Worn piston ring Loose spark plug Air leakage at the cylinder head, incorrect valve clearance or timing.	Replace it. Tighten it. Removal, re-adjustment or re-installation
	Normal ignition and oil supply	Poor contact between the high-tension line and the spark plug Malfunction or short-circuit of shutdown switch	Removal and connection Removal

After removing carbon accumulated on the electrodes and the insulator, adjust the clearance between the electrodes at 0.6 ~ 0.7 mm



When mounting the plug cap, push it in securely

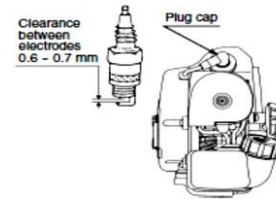

### Cleaning of fuel filter

Using a piece of wire, or the likes, pull out the fuel filter and wash with clean white kerosene. When it is fouled heavily, replace the filter and also wash the tank inside.

**⚠ Use of fire is strictly prohibited**

### Carbon removal

Remove carbon from the muffler in-/outlet, cylinder and piston. This work requires engine servicing skill and some tools. Consult the dealer or nearest service center.

### ⚠ CAUTIONS DURING INSPECTION

- Disconnect the ignition plug wires before inspection or adjustment to prevent unexpected start of engine.
- Do not touch the engine immediately after operation to prevent burn.
- Use of fire is strictly prohibited when handling the fuel (gasoline).
- Make sure to clean spilled fuel sufficiently before using the engine.
- Do not wash the engine with water.
- Do not change the setting revolution speed carelessly. (Consult your dealer when changing the revolution speed.)

## STORAGE

When releasing the engine from operation for more than 30 days, it must be serviced and stored as follows with care to prevent the starting trouble or malfunction due to degeneration of fuel.

1. Drain the fuel from the fuel tank and start to run the engine till it is stopped due to use-up of fuel.
  2. Wash the inside of fuel tank and fuel filter with white kerosene.
- ⚠ Use of fire is strictly prohibited**
3. Removing the ignition plug, inject a small quantity of new engine oil through the plughole. After idling slowly for few revolutions operating the recoil starter, install the ignition plug. Pull the recoil starter again and stop it at the position where it is felt heavy.
  4. Clean the external surfaces with soft cloth and store it at a dry place free from fires.

## BEFORE GETTING STARTED

Before using the machine for the first time be sure to read through this manual in order to avoid wrong operation. Please preserve this manual properly so that it can provide you with information whenever necessary.

### SAFETY SYMBOLS ON THE MACHINE:

Wear goggles, ear protection and head protection.	
Wear protecting gloves	
Wear safety shoes with hard sole.	
Read through this operation instruction before you use the device.	
Ensure cutting head is not touching foreign matters while starting and during operation.	
To reduce the risk of injury or damage, avoid contact with any hot surface.	
Keep all bystanders at least 15m away from the work area.	
Cutting string: maximum allowable rotate speed	
Cutting blade: maximum allowable rotate speed.	
A hazard from fire/flammable materials.	

### INSPECTION AND SERVICE

**Symbols on the filter cover:**

Cold starting position of the handle at "choke" Operating position of handle at "running".	
Mixing ratio: 50:1, only suitable for mixed fuel	

### SAFETY INSTRUCTIONS

This section states the basic safety rule for using gasoline-driven brush cutter and grass trimmer.



**Please pay attention to safety instructions when using machine.**

- Before you use this machine, check all the operating parts, to ensure safe use. You shall practice to use this machine and let skilled person or professional instruct its functions, operational mode and operating skill who shall ensure you can immediately stop the device in case of an emergency. Using this machine against the instructions given may result in serious injury.
- Wear proper protective suit:**
  - Put on protection goggles and hearing protection devices and safety helmet.
  - Wear your protection gloves
  - Wear safety shoes with strong soles.
- Dress properly, do not wear loose clothing or jewellery that could become caught in moving parts of the unit. Safe, sturdy, nonskid footwear should always be worn. Long hair should be tied back. It is recommended that legs and feet be covered to protect from flying debris during operation.
- Inspect the entire machine for loose parts (nuts, bolts, screws, etc.) and any damage. Repair or replace as necessary before using the machine.
- Keep the handles free from oil and fuel.
- Always use proper handles and shoulder strap when cutting.
- Never attempt to make engine adjustments while the unit is running and strapped to the operator. Always make the engine adjustments with the unit resting on a flat, clear surface.
- Never remove the machine's guard. Serious injury to the operator or bystanders could result as well as damage to the machine.
- Inspect the area to be cut and remove all debris that could become entangled in the nylon cutting head.
- Never leave the machine unattended.
- This machine must not be used by children. The person who does not completely understand this operation instruction must also not use this device. The law and local regulation may prescribe the user's minimum age.



Table of regular inspections

Item \ Time	Before Each Operation	At Every 50-hours	At Every 100-hours	2 Years
Inspection and retightening of bolts, nuts	✓			
Inspection of fuel leakage	✓			
Inspection, cleaning of air cleaner	✓			
Cleaning at cooling air inlet, cooling fin and around muffler	✓			
Inspection, cleaning of ignition plug		✓		
Inspection, cleaning of fuel filter		✓		
Removal of carbon from muffler, cylinder		✓		
Cleaning of spark arrestor		✓		
Replacement of ignition plug			✓	
Replacement of fuel piping (fuel pipe and grommet)				✓

#### INSPECTION AND SERVICE BEFORE EACH OPERATION

##### Cleaning of air cleaner

Wash the element with white kerosene and then immerse it in engine oil. Squeeze it tightly with single hand.

**Use of fire is strictly prohibited**

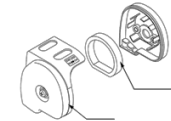

##### Cleaning and service at respective sections

- Clean thoroughly around the muffler.
- Clean the cooling fins and the cooling air inlet.
- Inspect and retighten bolts and nuts.
- Inspect the fuel leakage.

#### INSPECTION AND SERVICE AT EVERY 50-HOUR

##### Cleaning and adjustment of ignition plug



**ADJUSTING THE CARBURETOR**

**!** Engine revolution speed is adjusted at the optimum condition before shipping from the factory. It should be adjusted only when it fails to operate properly. (Consult your dealer when adjustment is necessary.)

1. Use the slow speed adjusting screw to adjust the slow speed revolutions.
  - Right turns: Increase the revolution speed.
  - Left turns: Slow down the revolution speed.

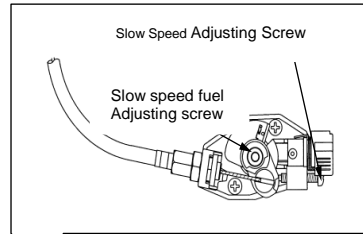

**!** Increasing the slow revolution excessively causes the driven equipment unable to stop even if the throttle lever is returned. The revolution speed should not be increased excessively.

2. In case with the slow speed fuel adjusting screw Normal position is where it is returned by one turn from the fully closed position (right turn).
  - Right turns: Increase the thickness of fuel.
  - Left turns: Decrease the thickness of fuel.

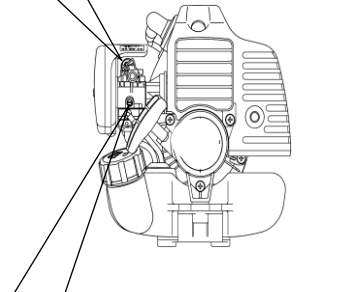

3. In case with the high speed fuel adjustment screw
  - Right turns: Decrease the thickness of fuel.
  - Left turns: Increase the thickness of fuel.

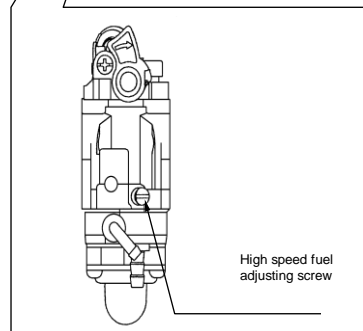

**!** Fuel adjustment for the carburetor is completed at the optimum condition before shipping from the factory. When it is necessary to adjust, consult your dealer.

**!** Do not decrease the thickness of fuel too much. (It could result in the seizure trouble of engine.)

12. Please keep the machine away from kids and pets. If there is human or animal staying around, you need to halt your operation. You shall keep 15-meter as safety distance in any occasion. The stone and cobble are likely to be ejected due to centrifugal force, and therefore result in injury.
13. Do not use this type of machine for sweeping away debris or any other job which it is not intended as described in this manual.
14. Use nylon cutting head which is free of damage. If a stone or any other obstacle is hit, stop the engine and check the nylon cutting head. A broken or unbalanced nylon cutting head must never be used.
15. Before operation, please check for any hard articles such as stone, metal parts on the ground. The thing ejected by centrifugal force may have injury risk.
16. In the operation area, the user shall be responsible for the injury of the third person because of the operating device.
17. Do not operate the device if you are tired/drunken, have taken medicine or drugs which may cause drowsiness. Have a break during your work.
18. Do not smoke around the device during operation or while fueling. Otherwise, there is a risk of fire, if gasoline vapor leaks out.
19. Please give the device to a person who can operate it safely.
20. The engine should be turned off when the machine is moved between work areas.
21. Do not operate in rain, or rough weather or moist environment. Ensure proper lighting while operation.
22. Do not operate with the damaged, uncompleted or removed device without manufacturer's permit.
23. Do not operate if the device does not have muffler or the muffler is faulty. Do not touch hot muffler, vent-pipe and ignition cable. Otherwise you may be injured.
24. Do not use saw blade, iron wire or threshing flail. Do not use cutting tool or attached tool not specified in this operation instruction. Otherwise, you may be injured.
25. Check for the safety of the tool before operation. Particularly, check:
  - Start/Stop switch,
  - Throttle lever and throttle lever lock,
  - Function of the safeguard,
  - Whether the cutting tool is fixed safely, without damage or wear and tear,
  - All bolts and locking devices are fixed properly.
  - The hands are clean and dry.
26. Ensure the nylon cutting head does not touch stone, cobble, iron wire and other foreign matters when it is getting started and during operation. Unreasonable rough operation will shorten the life of the machine as well as create an unsafe environment for yourself and those around you.
27. If you slip or fall to the ground or into a hole, release the throttle lever immediately.
28. Start the machine according to the instructions given in this operation manual. Do not over turn the device while starting the device.
29. Do not start the device in a closed or poorly ventilated space. Otherwise, you may inhale exhaust gas from the engine.

30. While starting the engine and during the operation, keep your body away from the device, especially your hands and feet.
31. Always keep safety cover, cutting head and cutting device out of cutting scraps.
32. Exposure to vibration and cold may cause tingling and burning sensations followed by loss of color and numbness in the fingers. The following precautions are strongly recommended because the minimum exposure which might trigger the ailment is unknown.
  - Keep your body warm, especially the head, neck, feet, ankles, hands, and wrists.
  - Maintain good blood circulation by performing vigorous exercises during frequent work breaks and also by not smoking.
  - Limit the hours of operation. Try to fill each day with jobs where operating the brush cutter or other hand held power equipment is not required.
33. Do not carry the running device to walk through the pebble path or street.
34. Check the engine in idle running condition. When you release throttle to run idle, the cutting tool must stop after a short time.
35. Do not stop the cutting tool with your hand. Wait until it stops automatically.  
**Note:** *The cutting head will rotate for few seconds even after you stop the device.*
36. Pay attention to safety condition during operation. Do not adopt a bad body posture. Specially be careful when you work on slopes and stand along the downgrade according to the cutting direction. When there is slipping risk, do not operate at any cost (for example, wet road, snow, etc.).
37. This device is designed for operation with two hands. The thumb and other fingers must tightly hold the handle. Do not operate with only one hand. Use shoulder harness during operation.
38. Operate carefully in the area with dense plants and where the vision is not clear. Pay attention to the plant root and stub. Otherwise, you may trip over.
39. Do not use this device to cut the grass not grown on the ground, such as the grass grown on the wall or rock.
40. Always keep the cutting tool touch the ground during operation. Do not lift up the device when you operate.
41. Do not use the device when you are away from others for help or out of others' vision field, because they can rescue you in emergency.
42. In the following cases, you shall stop the engine (Start/Stop switch):
  - While fueling up the device.
  - While not using it.
  - While putting it down occasionally.
  - While cleaning the device.
  - While moving it from one place to another.
  - While removing or replacing the cutting machine.
43. Pay attention to the cutting wire, which may cause serious cutting wound.
44. Always carry the device by holding shoulder harness or grasping transmission tube.
45. **Take measures against bounce-back:**

of the gasoline during its operation. Immediately shut down the engine in case of abnormal sound, severe vibration, unstable rotating speed, blasting and other adverse phenomena of the gasoline engine.

### PRECAUTIONS DURING OPERATION

- After starting the engine, set the throttle lever at the slow speed position and warm up the engine for approx. 2~3 minute. As the engine warms up, the engine will be accelerated smoothly.
- Do not attempt to raise the engine speed abruptly immediately after the start because the lubrication oil may not be distributed yet all over the engine.
- If the throttle lever is turned to the fully opened position, the revolution speed picks up to a considerably higher level, which could not only shorten the life of engine but also cause trouble. It should be avoided to race the engine at high speed under no load condition or raise the speed unnecessarily.
- Before starting operation, make sure to inspect the engine in accordance with the "Inspection before starting the engine".
- Do not operate the engine at the indoor or a place with poor ventilation. (Exhaust gas contains odorless and harmful carbon monoxide.)
- Do not insert in or approach hands or foot at the moving or rotating sections.
- Stop the engine immediately if it has been discovered any leakage of fuel or gas from the carburetor, muffler, fuel tank, crankcase, cylinder or mating face at respective sections. (Contact a dealer or service center for repair.)
- Do not change the setting revolution speed of engine unnecessarily.
- Be careful not to touch highly heated muffler or sections on the engine to avoid possible risk of burn.
- Do not operate the engine while withered grasses, leaves or other inflammable substances are sticking in or around the muffler cover.
- Do not touch the ignition plug cap or high-voltage cord during operation. (There is risk of electric shock or physical injury.)
- Do not operate the engine with the muffler or air cleaner cover removed

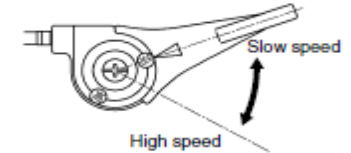

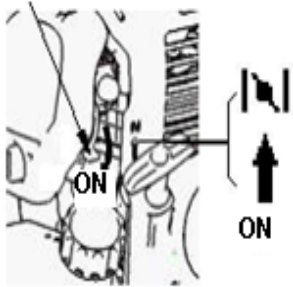
<p>In case of using the gasoline engine in the plateau region, the air and fuel mixture of the carburetor in the normal state will be too dense, which will reduce the running performance of the gasoline engine and increase the fuel consumption. Thus, the carburetor shall be replaced with a special one for use in the plateau region.</p> <p>With the increase of the elevation, the power of the gasoline engine will have some decline.</p>	<p><b>Handle of choke valve</b></p> 
---	---

**Operation:**

When preheating the gasoline engine, gradually move the handle of the choke valve to the "OPEN" position. Then, adjust the handle of the throttle valve upward and set it at the position of the required running speed of the engine.

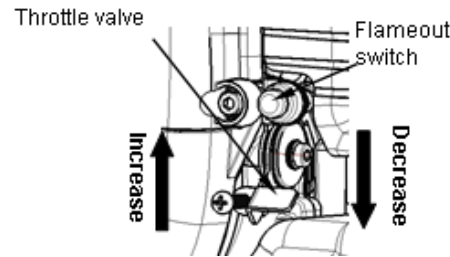

**CAUTION**

To give full play to the product performance, It is suggested to run the gasoline engine for about 15 minutes in the low-speed state if the engine is used for the first time. Heat the engine for 3~5 minutes and then get it into the working state every time when it is to be used.

**Shutdown**

Directly press down the stop switch or pull off the spark plug cap in case of shutdown in an emergency. Generally, conduct the operation based on the following steps:

1. Release the load firstly; then press down the handle of the throttle valve to reduce the rotating speed of the gasoline engine.
2. Press down the stop switch after 2~3 minutes of no-load running.

**CAUTION**

Under normal circumstances, it is strictly prohibited to directly shut the engine down in the case of no load off.

For the sake of your health, please be far away from the muffler and do not directly face the exhaust port during operation of the gasoline engine. Pay attention to the unusual change



The user may be impacted by the blade when it bounces back. The result may be that the user loses control of the device and may be injured seriously. Use it carefully and avoid bounce with appropriate skill.

46. When the metal cutting blade is used, the device may bounce back if the blade contacts the obstacles (stone, wood).
  - Hold the device tightly with your hands.
  - **Note:** Do not leave any obstacle on the ground and do not use metal cutting blade near a fence, metal column or similar materials.

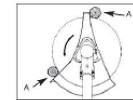

Use sharp cutting tool only. Set to position A when you cut dense branches.

**Fueling**



- The fuel and fuel vapor is flammable. Do not fill the fuel when the engine is running. Do not smoke and ensure good ventilation while fueling
- To prevent fuel blowing out, you shall cool the engine before you fuel up and open the fuel cap carefully. So as to avoid the risk of fire.
- Only use the mixed fuel recommended in this operation manual. Or the engine may get damaged.
- Do not use the machine near flammable liquid or gas. Regularly check if the fuel cap is sealed. Start the machine at least 3 meters away from the fueling point. Otherwise, it may cause fire or explosion.
- Please observe valid fire regulation and rules against fire issued by each state and country.
- Always mix and store the fuel in a properly marked container that is approved by local codes and ordinances for such usage.
- Never remove the fuel tank cap while the engine is running.

**Maintenance and Storage:**

- Maintain the device only when the engine has stopped completely (Exception: When adjusting carburetor and rotation speed). Remount the safeguard and other covers after finishing the maintenance.
- Wear protecting gloves while replacing the cutting tool.
- A cutting tool with a crack or a distorted tool cannot be repaired through welding and alignment.
- Do not try to repair the device by yourself. Only the authorized customer service personnel can do the work not specified in this operation manual.
- Only use the spare parts and fittings provided and recommended by the manufacturer.
- Only use the original cutting tool. You must not use metal wire instead of plastic wire.

- Store the device and fuel in a safe, dry place that is not accessible by children. Prevent any risk that can arise from overflowed fuel and vapor contact spark or open fire. The spark source may be produced by electrical appliance.
- Store the fuel in proper and permitted container. Clear up the oil tank for long-time storage and transportation. You shall clean up the waste working medium according to rule.

## APPLICATION

If the Brush cutter is fitted with **cutting string** as trimmer as attachment, it is used for **cutting grass** grown in **park, garden** and **around tree** or **fence**.

If the Brush cutter uses **metal cutting blade** as attachment, used for **cutting grass, weed** or **light plant**.

When Brush cutter uses **metal (TCT) cutting blade** with **paddy guard** as attachment, used for harvesting **paddy, wheat** and other **cereal crops**.

**Note:** Any other purpose not specified and permitted in this manual may damage device and cause serious injury to the user. Do not use this device to cut thorn, shrub or bush.

The manufacturer shall not be responsible for damage caused by wrong operation.

## GENERAL DESCRIPTION

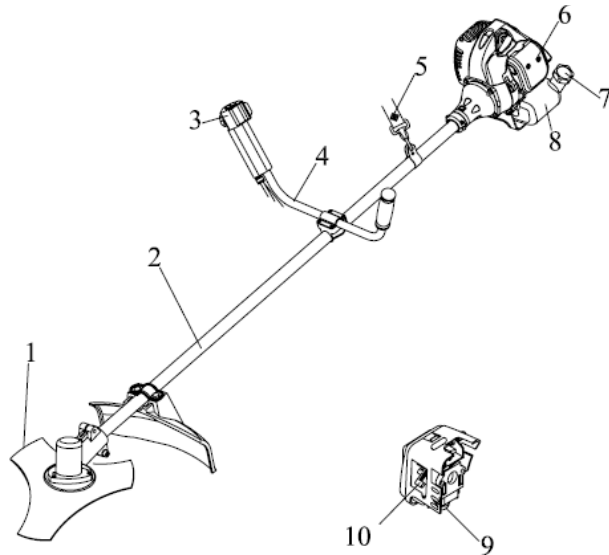

1. **Blade:** Circular blade for grass, weed or brush cutting applications. Harness, metal shield and U-Handles required for blade operation.
2. **Drive Shaft Assembly:** Contains a specially designed liner flexible drive shaft.
3. **Ignition Switch:** "Slide Switch" mounted on top of the Throttle Trigger Housing. Move switch FORWARD to Stop, BACK to Run.

## OPERATION INSTRUCTIONS-4 STROKE ENGINE

### Startup of Petrol Engine

<p>Forcibly press the oil pump until the fuel in the fuel pipe (transparent oil pipe) can be seen</p>	
<p>Pull the choke valve to the "OFF" position and return</p> <p><b>CAUTION</b></p> <p>Do not use the choke valve when the gasoline engine is hot or in the high-temperature state.</p>	<p><b>Handle of choke valve</b></p>
<p>Startup:</p> <p>Grasp the starter handle and slowly pull until you feel the resistance, then firmly pull it outwards.</p> <p><b>CAUTION</b></p> <ul style="list-style-type: none"> <li>• It is required to slowly lay back the handle along the resilience of the starter rope rather than abruptly release the handle and allow it to rebound and strike the gasoline engine, which will damage the starter.</li> <li>• It is required to quickly pull the starter, or the electrode of the spark plug cannot spark, which will consequently result in the starting failure.</li> </ul>	

- Turn the engine switch to the "OFF" position. (Switch position may vary depending on the specifications. Refer to the instruction manual of driven equipment.)  
In chase of a push button type switch, keep pressing the push button till the engine stops completely.
  - Replenish the fuel before using up completely. It will make easier at the next starting.
  - When there is no subsequent work, drain the fuel from the fuel tank and restart the engine to use up the fuel remaining in the carburetor.

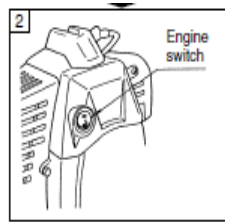

### CAUTION

- Place the engine at a horizontal position when the driven equipment is not used at the rest time, or others, in summer season. (If the tank is tilted as much as the inside of fuel cap is submerged in the fuel, the fuel may leak.)
- Do not touch the engine body, especially the muffler, during or immediately after stopping the operation. (There is risk of burn.)

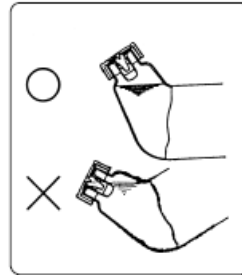

### Before operating a 4-Stroke engine:

**Caution** The gasoline engine is not filled with engine oil before it is delivered from the factory. Please fill it with engine oil firstly

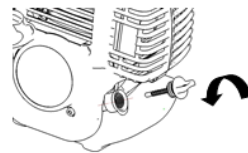

### Check the lubricating oil level

- Shut down the gasoline engine and place it at horizontal level.
- Dismount the engine oil rule and check the oil level, which shall be up to the oil filler.
- If the oil level is low, fill the recommended lubricating oil to the oil filler
- Remount the oil rule.

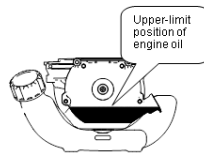

- U-Handle:** This handle can be adjusted at your convenience for comfort.
- Harness Assembly:** It is an attachment which hang the machine on the operator and adjustable in length.
- Air Cleaner Cover:** It contains replaceable filter element.
- Fuel Tank Lid**
- Fuel Tank:** It contains fuel and fuel filter.
- Purge Bulb:** Pushing purge bulb(7 to 10 times before starting), will remove all air and stale fuel from fuel system and bring fresh fuel to the carburetor
- Choke:** The choke control is located on the top of the filter cover.  
**Cold Start:** Pull lever up to close choke for cold starts .Push lever down for RUN position.

## ASSEMBLY

### Installing Plastic Shield:

- Install the safety cover on the shaft with the safety cover bracket and screws provided.
- Tighten the screws after setting the safety cover bracket at the appropriate position.

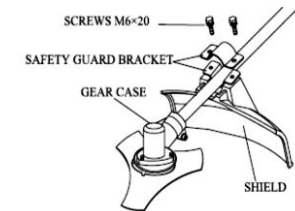

### Installing Handle:

Install handle in bracket. Position handle in a comfortable operating position and tighten four M5x16 screws. (Fig 1)

**Blade Installation:** Install holder A, the tri-blade, holder B, washer 8, in this clamp with a left hand thread bolt.

Align hole of gear case and holder A, and insert S=4 mm bar wrench. Rotate blade fastening bolt with plug box wrench in clockwise direction until securely tightened. (Fig 2)

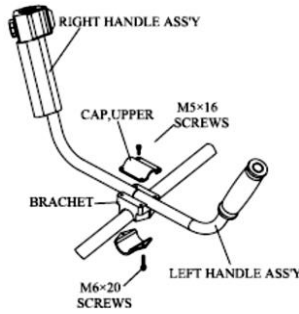

Fig 1.

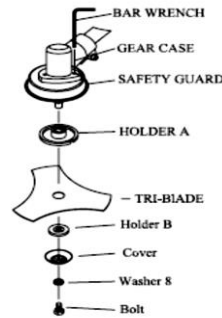

Fig 2.

 <b>CAUTION</b>	<p><b>Excessive Vibration-means-Stop the Engine immediately:</b>                  Excessive vibration of blade means that it is not properly installed. Stop the engine immediately and check blade. Improperly installed blade will cause injury. Use only original cutting equipment parts when servicing the unit.</p>
--------------------	---

**Rules for safe operation:**

- Be thoroughly familiar with the controls and proper use of the unit. Know how to stop the unit and shut off the engine .and unhook a harnessed unit quickly.
- Follow all the safety precautions given in this manual strictly.
- If the unit must be used where there are unprotected people, operate at a low throttle speed to reduce the risk of thrown objects.
- Move the stop switch to “stop” position when the engine idles, insure it reliable before cutting. The unit should be operated only when the stop switch is in good condition.
- Perform routine checks to ensure the cutting attachment stops turning when the engine idles.



**CUTTING WITH A NYLON HEAD**

Line head rotates in a CLOCKWISE direction .The CUT-OFF KNIFE will be on the right side of the debris shield.

6. If you move the throttle lever to the high-speed side a little after the engine has started, the starter lever returns to the operating position. Continue the warm-up operation for 2 to 3 minutes in this condition. Observing the condition of the engine, move the throttle lever to a desired engine speed.

**START**

**⚠ CAUTION**

- Before starting the engine, confirm that the area of radius 15 m around the engine is completely evacuated.
- Do not operate the engine when any flammable material (gasoline, volatile chemicals, or others) is present around it.
- Driven equipment may start simultaneously with the start of engine. Carefully read the instruction manual of the equipment and start the engine carefully.
- When a class FC oil is used, a larger resistance may be felt when pulling the recoil starter grip under low temperature condition or at the initial operation at the next season. This is related to the characteristic of the oil and there is no problem on the engine. Once started, it will return to the normal condition

**Concerning New Start System**

It can start even if it is pulled slower than normal.

- If the rope is pulled (vigorously) till it will not come out any more, it could damage the recoil mechanism.
- Do not disassemble the recoil.  
 It is dangerous to disassemble the inside of recoil. (Consult your dealer when it is necessary to replace related parts.)
- If the decompression slot of cylinder is clogged, the engine may start slower than normal. Clean the slot to restore the normal condition.

**STOP**

1. Set the throttle lever at the slow speed position.

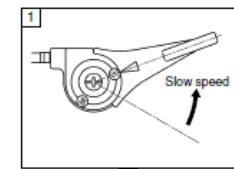

### START (STARTER LEVER TYPE UNIT)

1. Turn the engine switch to the "ON" side.

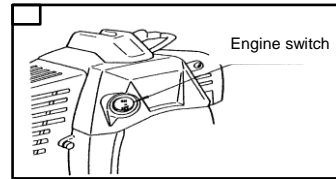

2. Set the throttle lever at the slowest speed position.

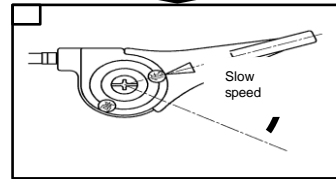

3. Push the priming button repeatedly with finger till it hits the top. (More than 10 times)  
Pressing the priming button is necessary to prime the fuel to facilitate the start-up. Since any excess amount of primed fuel returns to the tank, there is no problem of over-priming. Prime the fuel rather more than sufficiently to avoid starting trouble.

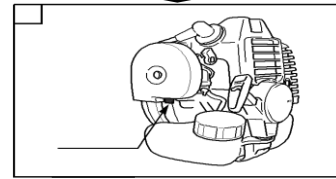

4. Turn down the starter lever of carburetor to set it at the start position.  
It is not necessary to operate the starter lever when the engine is warmed up (For about 15 minutes after stopping the engine.)  
(To be left in the operating position)  
Depending on specifications, the starter lever may be provided at the throttle wire side.

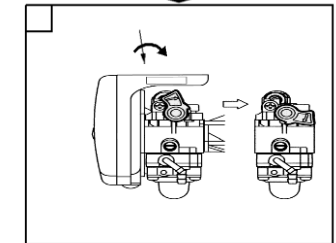

5. While holding down the engine firmly, grasp the recoil starter grip and pull vigorously

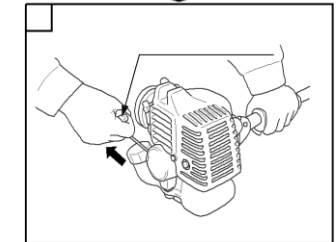

### CAUTION:

- a) When the engine stops on the way after starting, or
- b) When the engine fails to start after trying the recoil operation for 7 to 8 times.

Return the starter lever to the operating position and try the recoil operation.

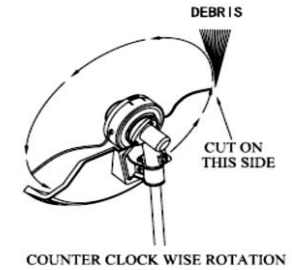
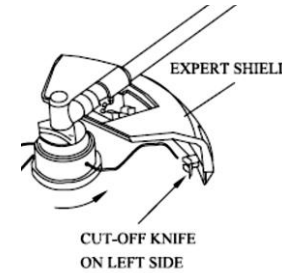

For nearly all cutting, it is good to tilt the line head so that contact is made on the part of the line circle where the line is moving AWAY from you and the debris shield. This results in the debris being thrown AWAY from you.

### WARNING:

1. The proper debris shield must be in place on the unit when nylon cutting line is used. The cutting line can flap around if too much line is exposed. Always use the plastic debris shield with cut-off knife when using nylon cutting heads.
2. Tilting the head to the wrong side will shoot the debris TOWARDS you. If the line head is held flat to the ground so that cutting occurs on the whole line circle, debris will be THROWN at you, drag will slow the engine down, and you will use up a lot of line.
3. Use only quality nylon monofilament line of the diameter 2.5mm. Never use wire or wire-reinforced line in place of nylon trimmer line. Load your nylon line cutting head only with nylon trimmer of the proper diameter.
4. Use extreme caution when operating over bare spots and gravel, because the line can throw small rock particles at high speeds. Debris shields on the unit cannot stop objects which bounce off hard surfaces.

### TRIMMING:

This is feeding the trimmer carefully into the material you wish to cut. Tilt the head slowly to direct debris away from you. If cutting up to a barrier such as fence, wall or tree approach from an angle where any debris ricocheting off the barrier will fly away from you. Move the line head slowly until the grass is cut right up the barrier, but do not jam (overfeed) the line into the barrier. If trimming up to a wire mesh or chain linked fence be careful to feed only up to wire. If you go too far the line will snap off around the wire. Trimming can be done to cut through weed stems one at a time. Place the trimmer line head near the bottom of the weed never high up which could cause the weed to chatter and catch the line.

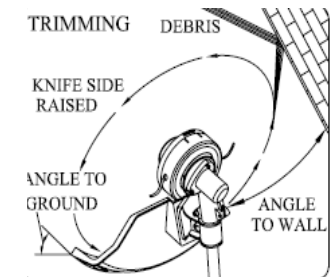

Rather than cut the weed through, just use the very end of the line to wear through the stem slowly.

### SCALPING and EDGING:

Both of these are done with the line head tilted at a steep angle.

**SCALPING** is removing top growth leaving the earth bear.

**EDGING** is trimming the grass back where it has spread over a sidewalk or drive way. During both edging and scalping, hold the unit at a steep angle and in a position where the debris, and any dislodging dirt and stones, will not come back towards you even if it bounces off the hard surface. Although the picture shows how to edge and scalp every operator must find for himself the angles which suits his body size and cutting situation.

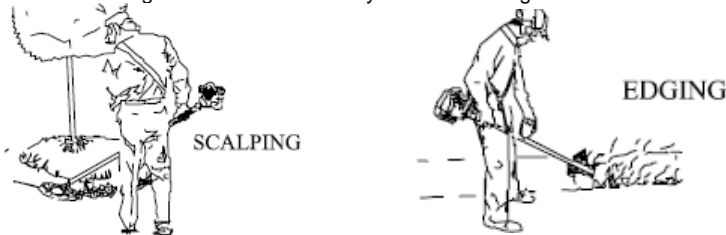

**Note:** Do not use a steel blade for edging or scalping.

Do not trim in any area where there are strands of fencing wire. Wear safety wear. Do not cut where you cannot see what the cutting device is cutting.

### Cutting with a Blade:

There are different types of blades, however the two most commonly used are the following:  
**BRUSH BLADE** is used for cutting brush and weeds up to 3/4" in diameter. Only 255mm, 3-blade can be used in this type of brush cutter.

**SAW BLADE** is used for cutting growth from 3/4" to 3" in diameter.





#### WARNING:

1. Use the shoulder harness at all times. Adjust both harness and harness clamp on the unit so that the unit hangs a few inches above ground level. The cutting head and the metal debris shield should be level in all directions. Harness the unit on the right side of your body.
2. **Do not use a brush cutter for cutting trees.**
3. Do not cut with dull, cracked or damaged metal blade. Before cutting growth, inspect for obstruction such as boulders, metal stakes or strands of wire from broken fences. If an obstruction cannot be removed, mark its location so that you can avoid it with the blade. Rocks and metal will dull or damage a blade. Wires can catch on the blade head and flap around or be thrown into the air.

## OPERATION INSTRUCTIONS - 2 STROKE ENGINE

### Methods of starting & stopping the engine

#### START (CHOKE TYPE UNIT):

1. Turn the engine switch to the "ON" side.
2. Set the throttle lever at the slow speed position.
3. Push the priming button repeatedly with finger till it hits the top. (More than 10 times) Pressing the priming button is necessary to prime the fuel to facilitate the start-up. Since any excess amount of primed fuel returns to the tank, there is no problem of over-priming. Prime the fuel rather more than sufficiently to avoid starting trouble.
4. Turn the choke lever to the fully closed position (at the  Mark). When sufficient fuel is retained and the engine is warm, set the choke lever at the fully opened position (at the  mark).
5. While holding down the engine firmly, grasp the recoil starter grip and pull vigorously.
6. When the engine has started, return the choke lever gradually to the fully opened position (at the  Mark).  
 If only exploding sounds are heard, but it does not start, return the choke lever to the fully closed position and pull the starter grip vigorously once again.

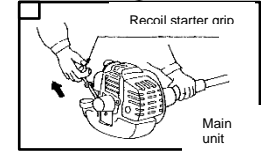
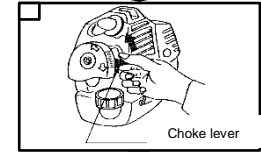
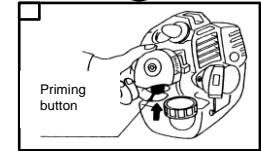
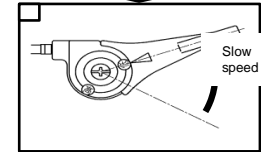
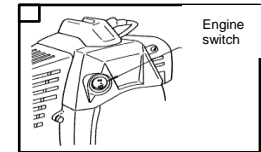



### INSPECTION OF RESPECTIVE SECTIONS:

Make sure to inspect these sections before operating the engine.

#### Inspection of fuel

- Is sufficient quantity of oil reserved?
- Is not the fuel degenerated?
- Use the proper fuel referring to the "Fuel" section.

#### CAUTION

- Sufficient care must be taken on the fire not only when replenishing but also handling fuel. It could cause fire or explosion.
- Securely close the oil tank cap. Fuel may leak if the cap is tightened aslant. It will never leak if the cap is tightened properly.  
(Excluding: TL tank cap breather type)

#### Inspection of clogging

- Check the cooling fins, around the muffler and cooling air inlet for trash or withered grasses trapped.
- Remove them if necessary

#### Inspection of air cleaner

- Is not fouled the air cleaner element?
- When the element is fouled or it is not impregnated with oil, inspect and service it in accordance with "Inspection and servicing before each operation"

#### Inspection of screws and nuts

- Check respective sections for loose or missing screws or nuts.
- Service them if necessary.

#### Inspection of fuel pipes

- Check for cracks or fissures on the fuel pipe and grommet, disconnection or fuel leakage from joints on the fuel tank and carburetor.

#### CAUTION

Cracks, fissures or disconnection from joints could cause fire or explosion by leaked fuel. Service or replace damaged fuel pipe and grommet.

**WARNING ⚠ DANGER**

DO NOT TOUCH THESE TYPES OF OBJECTS WITH BLADE

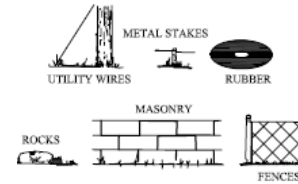

**SCYTHING WEEDS:** This is cutting by swinging the blade in a level arc. It can quickly clear areas of field grass and weeds. Scything should not be used to cut large, tough weeds or woody growths.

**Note:** Do not use a brush to cut trees which exceed a diameter of 1/2 to 3/4 inches.

Scything can be done in both directions, or just in one way which results in the debris being thrown away from you.

That is using the side of the blade that is rotating away from you. Tilt down the blade slightly on this same side. You will be hit by some debris if you scythe in both directions.

**SAWING:** This must be done with a saw blade when the weeds are too thick and strong for scything.

If kickback occurs, the blade may be dull, or the material so thick and hard that you should use a saw blade instead of brush blade.

Growth up to 3-inches in diameter, which is too thick for scything, may be cut by sawing. Sawing requires judgment on your part whether to cut on the side where the blade pulls away from you but throws back the debris, or on the side where the debris is thrown away from you but the reaction is push which could become a kick out (blade thrust).

Always cut on the side of the tree which will cause the tree to fall away from the unit. A kick out or bind may result if the tree falls toward the unit and pinches the blade.

Do not force the blade to cut. Do not change the angle of cut after inserting into the wood. Avoid using any pressure or leverage which could cause the blade to bind or crack.

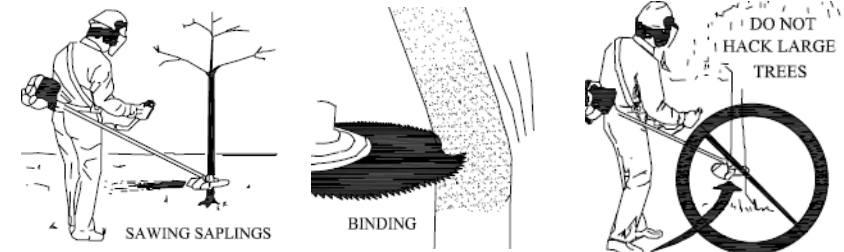

## FUEL HANDLING

1. Keep good ventilation when disposing fuel.
2. Do not smoke when fueling up and keep away from all the heat sources.
3. Be sure to wipe off spilled fuel before attempting to start engine.
4. Do not fuel up when the engine is running/hot.
5. Never fill the fuel tank to the very top.
6. Carefully open the fuel tank cap, to slowly eliminate the possible existing excess pressures.
7. Keep at least 3 meters from the fueling point when you start the machine. Otherwise it may cause fire or explosion.

**Note:** Use only the mixed fuel recommended in this operation manual. The mixed fuel tends to age. Therefore, you shall not use the mixed fuel that has been stored for over 3 months else it may damage the engine.

	Do not let your skin directly touch gasoline or absorb gasoline vapor which may affect your health badly.
	The machine is equipped with a two-stroke engine and is driven by using mixed fuel of <b>40:1</b> gasoline and two-stroke engine oil.

- Use lead-free quality gasoline (octane rating = 90 at least). Never use gasoline mixed with alcohol or either compound or oxygen-enriched gasoline.
- Use the ESSO FC class two-stroke engine oil to get the best result. If this oil cannot be provided, use superior oil to the two-stroke engine.
- Dispose waste gasoline and cloth wet with gasoline according to government regulation

**Note:** Do not use pure fuel. Observe the mixing ratio precisely according to the rule. Do not use the mixed fuel that has been stored over 90 days. Do not use two-stroke oil to water cool engine or four-stroke engine. Otherwise, the engine may be damaged and you may not meet the condition for quality assurance.

1. Always mix gasoline and oil in a clean special container.
2. First add half volume of gasoline and whole volume oil and stir up the container. At last add the rest of the gasoline and stir it up again.
3. Screw off the fuel tank cap and add mixed fuel into the tank. Wipe off the gasoline around the cap and put on the cap again.
4. Two-stroke fuel may separate. Shake fuel container thoroughly before each use.
5. When mixing gasoline with two cycle engine oil, use only gasoline which contains no ethanol or methanol (types of alcohol). This will help to avoid possible damage to the engine fuel lines and other engine parts.
6. Do not mix gasoline and oil directly in the engine fuel tank.
7. Failure to follow proper fuel mix instructions may cause damage to the engine.

## OPERATION

### Pre-Operation Checks:

1. Check for loose bolts, nuts and fittings. Tighten them if necessary.
2. Check the air cleaner for dirt. Clean the air filter of all dirt, etc. before operation.

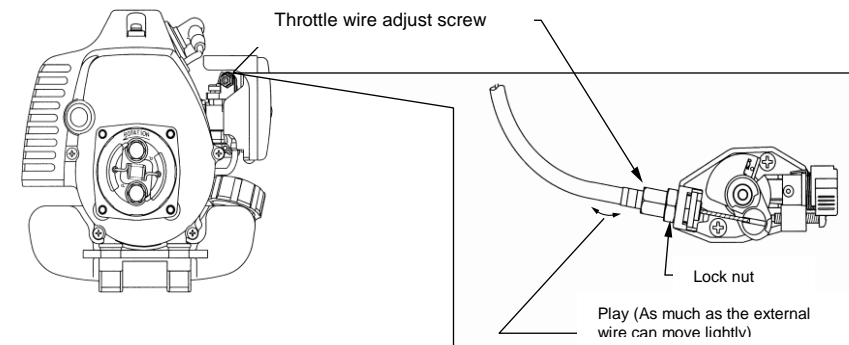

### For 4-Stroke engine:

**Caution** The gasoline engine is not filled with engine oil before it is delivered from the factory. Please fill it with engine oil firstly

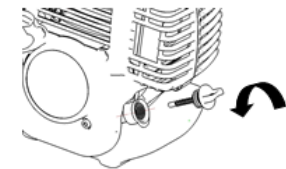

The fuel tank shall not be overfilled (The fuel level shall not be higher than the neck of the oil filler); inspect whether the fuel tank cap is properly covered after the refueling is completed.

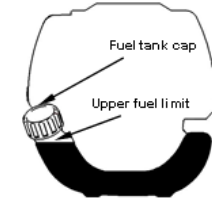

### Check the lubricating oil level

1. Shut down the gasoline engine and place it at horizontal level.
2. Dismount the engine oil rule and check the oil level, which shall be up to the oil filler.
3. If the oil level is low, fill the recommended lubricating oil to the oil filler
4. Remount the oil rule.

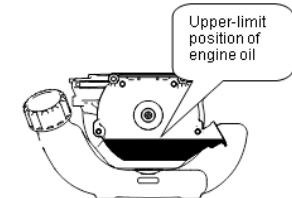

### COMPONENTS OVERVIEW (2 Stroke)

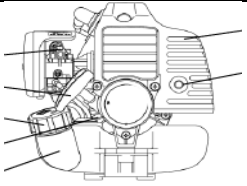
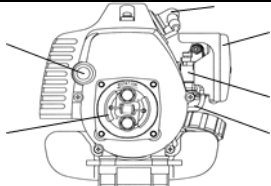
	
<ol style="list-style-type: none"> <li>1. Recoil starter grip</li> <li>2. Starter lever</li> <li>3. Cooling air inlet</li> <li>4. Fuel tank cap</li> <li>5. Fuel tank</li> <li>6. Muffler</li> <li>7. Exhaust outlet (Types vary depending on the specifications.)</li> </ol>	<ol style="list-style-type: none"> <li>8. Engine switch (Types vary depending on the specifications.)</li> <li>9. Clutch</li> <li>10. Ignition plug cap</li> <li>11. Air cleaner</li> <li>12. Carburetor</li> <li>13. Priming button</li> </ol>

### INSPECTION BEFORE OPERATING THE ENGINE

**NOTE:** In **2 Stroke** engine the gasoline and engine oil are mixed and poured together.

In **4 Stroke** engine the gasoline and engine oil are poured separately

**FUEL:** Use mixed oil of ordinary regular gasoline for vehicle and special 2-cycle engine oil with the proportion as shown by the following table.

Mixing ratio (Volumetric ratio):

Petrol : 2-cycle engine oil
40: 1

- Do not use degenerated oil (with sour smell).
- (It could cause engine trouble such as the starting error, insufficient output, etc.)
- Make sure to clean spilled fuel. It could foul clothes or cause fire.
- Do not use 4-cycle engine oil. (It could cause fouled plug, bound piston ring, clogged muffler, or other problem.)
- Take care while handling gasoline. (As there is a risk of explosion.)

#### ADJUSTMENT OF THROTTLE WIRE:

Adjust the play on the throttle wire to 0.5 ~ 1.0 mm.

#### LARGER PLAY

- It could cause the starting trouble.
- Revolution speed could rise unexpectedly when the external wire of throttle wire comes off from the position.

#### NO PLAY

- Driven equipment may fail to stop even if the throttle lever is returned.

3. Check to make sure that protector is securely in place.
4. Check to make sure that there is no fuel leakage.
5. Check to ensure that the blade is crack free.

 Do not use this machine without attachment guard. Check its function before using each time.

**Note:** Pay attention to protect from noise and abide by the local regulation while operating on special days (such as Sunday and holiday), at special time in a day (such as noon, quiet night) or in special area (such as hospitals, schools, etc.,) the machine is limited or prohibited to use.

 Always tie up shoulder harness when you are operating this machine. Always stop the machine when you loosen the shoulder harness. Otherwise it may cause accident.

#### Tie Up Shoulder Harness:

Adjust shoulder harness length and make snap hook at 10 cm lower than hip.

**Note:** Take off the tool before you start engine and fix it on the shoulder harness when the engine is rotating.



#### Starting a Cold Engine:



Do not start the engine near fueling point.

1. Move the stop switch to "START" position.
2. Give a gentle push on the primer pump repeatedly (7-10 times) until fuel comes into the primer pump.
3. Cold Starts: Pull lever up to close choke.
4. Pull starter handle until engine false fires.
5. Push choke lever inwards (excessive cranking with choke lever will cause flooding engine making it difficult to start.)
6. Pull starter handle until engine starts.
7. Allow engine to warm up for a few minutes before using.

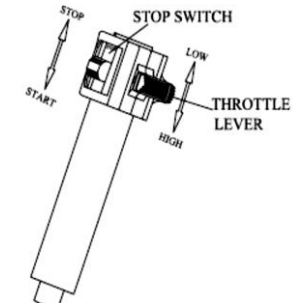

#### Starting a Warm Engine:

If the fuel tank was not run dry, pull starter one to three times and engine should start.

**NOTE:** DO NOT USE CHOKE.

If fuel tank was run dry, after refilling repeat steps 3 through 7 in "Starting a cold engine".

#### Stopping the Engine:

Move switch to STOP position.

### Check the engine for idle run

The cutting tool must be in idle run state. When throttle level is loosened, stop it.

**Note:** Even after you stop the device, the cutting tool will keep rotating for several seconds.

### General Operation Instructions

- If you are not confident with using this machine, please practice when the engine is not running.
- Always trim or cut in upper rotation area.
- When you start engine or the engine is running, keep the cutting tool away from your body, especially hand and foot.
- Regularly use screwdriver or equivalent tool to clear the protective cover, cutting head and all cutting scraps on the cutting device. The engine must stop so that you can avoid the transmission tube from getting overheated.

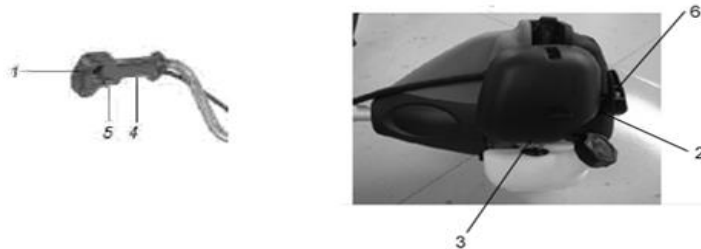

### Angle cut:

You can make 0°, 90° left and 90° right cutting by rotating long-handle tube.

1. Loosen bolt on joint. Press unlocking bolt and rotate transmission tube to the desired position.
2. Lock the lower transmission tube and unlocking bolt to the desired hole, and tighten the bolt again.

### Use cutting string:

Use only the original cutting tool. It is forbidden to use metal wire instead of plastic wire.

- Always make the cutting head touch the ground and move it right-and-left.
- Never keep the cutting head inclined and do not uplift it from the ground.
- When you cut high grass, cut it layer by layer top to bottom.
- When you cut grass around tree, fence or other obstacle, you shall use cutting wire end to cut and walk slowly around the obstacle.
- Do not touch hard obstacle (stone, wall, wood fence, and so on). Otherwise the cutting wire will be worn soon. Use protective cover edge, to maintain the right distance.



- Do not check sparks while the ignition plug is removed.
- Do not operate the engine with the muffler or air cleaner cover removed. (Inspect particularly the muffler at regular intervals for loose mounting screws, breakage or leakage, and repair or replace it if any abnormality is observed.)
- Do not operate the engine when grass, leaves or inflammable substances are sticking in or around the muffler.
- Do not touch parts of muffler or engine at high temperatures. (There is risk of burns.)
- Do not touch the ignition plug or high-voltage cord during operation. (There is risk of electric shock or physical injury.)
- Make sure to stop the engine whenever the work is interrupted or moving the engine to another place.
- Do not operate the engine alone. (It must be connected to the driven equipment when it is operated).
- Check frequently the parts used on the fuel line for cracks or leakage, and replace them if necessary.
- Remove dirt, grass or other trash from the cooling fins and the cooling air inlet. (Make sure to stop the engine and the driven equipment before the cleaning.)
- Make sure to use always new gasoline. (Old gasoline may cause sticky substance adhering at the inside of carburetor causing trouble in operation.)
- Before starting the engine, confirm that the area of radius 15 m around it is evacuated and no tank filled with fuel, or others are not left over.
- Use only genuine parts supplied from the manufacturer. Use of parts other than the genuine parts could cause engine trouble or premature abrasion.

**Note:** Important safety items quoted in this manual do not necessarily cover all situations or conditions that could occur. Although sufficient care has been taken to assure the safety of the engine, operators or service personnel must observe necessary precautions to operate it safely and protect themselves from possible dangers.

PETROL ENGINE – OPERATION MANUAL

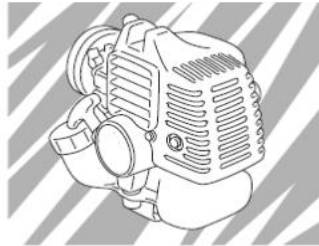

2-STROKE

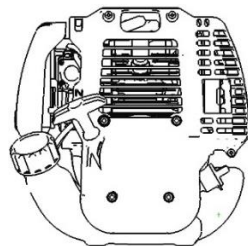

4-STROKE

BEFORE GETTING STARTED

This manual describes various cautions necessary to operate the engine properly. Before starting the engine, read the manual and understand the proper method of use. (Improper use of the engine could result in accident or injury.)

Use the engine after reading and understanding also the manual of equipment driven by the engine.

Keep the manual at a safe place where you can refer whenever needed.

SAFETY INSTRUCTIONS

	You have to observe the descriptions indicated with this mark because they contain very important information to assure the safety
--	--

- No person who does not understand the content of this manual should be allowed to operate the engine.
- Engine should not be operated indoors or in places with poor ventilation. (Exhaust gas contains odorless and harmful carbon monoxide.)
- Do not insert in or approach hands or foot near the moving or revolving sections.
- Do not store, spill or use gasoline at the vicinity of fire, stove, furnace or devices using the pilot flame or sparks like water heater or others. (There is risk of explosion.)
- Do not refill the fuel indoors or at a place not well ventilated.
- Do not smoke while filling the fuel.
- Do not remove the fuel tank cap or refill the fuel while the engine is still running or immediately after operation when the engine is still hot. (Wait for more than 2 minutes after terminating the operation before refilling the fuel.)
- Do not operate the engine when gasoline has spilled, smell of gasoline is felt as there is a risk of explosion.
- Do not adjust the setting engine speed unnecessarily.

**Note:** The too short or over worn cutting wire has poor cutting effect. Therefore, when the cutting efficiency reduces, you shall timely extend cutting wire (Refer “Extend cutting wire”) and check cutting string has enough cutting wire (Refer to the “Replace cutting string” in the Maintenance section).

**Extend cutting wire:**

Your machine is equipped with a double automatic cutting wire device. That means when the loop head touches the ground, two cutting wires will extend automatically. If the cutting wire is longer than the cutting range, the cutting wire will automatically shorten by the right length from the cutting blade.

**Note:** To cast no effect on cutting result, you shall regularly clean the grass left on the cutting tool.

You need to regularly check if the cutting wire is damaged or if its length conforms to the limited length of cutting blade

**When cutting effect decreases:**

Please start engine and keep the device on the lawn surface.

Slightly make cutting head touch the ground, and the cutting wire will extend automatically.



**When cutting wire head cannot be automatically extended:**

- Stop the device
- Press loop core, until it touches block, and pull forcibly the cutting wire end.

**When you cannot see cutting wire end:**

- Replace the cutting string (Refer “Replace cutting string” )

**Use metal cutting blade:**



Always tie up shoulder harness and wear suitable protective overalls during operation.

Mount cutting blade according to instructions given.

Replace the damaged or blunt cutting tool, otherwise there is risk of injury.

- Only use cutting blade to handle the flat surface. Carefully check cutting surface and clear up all foreign matters. Avoid touching the stone, metal or other obstacles. Otherwise, the cutting blade may be damaged or bounce back.

During operation always keep the cutting head on the ground and move it right-and-left in regular arc form.



- Do not keep the cutting head inclined and do not uplift it from ground.
- Do not use the device to cut wild plant, dense bush or lower bush in woods.
- Regularly check the metal cutting blade for any damage, and replace the damaged cutting blade.

**MAINTENANCE**

**Air Filter:**

1. Accumulated dust in the air filter will reduce engine efficiency. Increase fuel consumption and allow abrasive particles to pass into the engine. Remove the air filter as often as necessary to maintain in a clean condition.
2. Light surface dust can readily be removed by tapping the filter. Heavy deposits should be washed out in suitable solvent.
3. Remove filter cover by loosening air filter cover knob

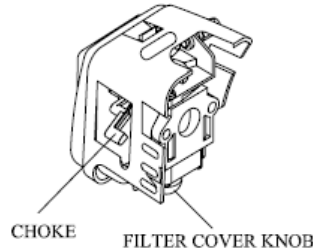

**Adjusting Carburetor:**

Do not adjust carburetor unless necessary. If you have trouble with the carburetor, contact your dealer. Improper adjustment may cause engine damage and void warranty.

**Fuel Filter:**

1. Fuel tank is fitted with a filter. Filter is situated at the free end of fuel pipe and can be picked out through fuel port with a piece of hooked wire or the like.
2. Check the fuel filter periodically. Do not allow dust to enter into fuel tank. Clogged filter will cause difficulty in starting engine or abnormalities in the engine performance.
3. When filter is too dirty, replace the filter.
4. When the inner side of the fuel tank is dirty, it can be cleaned by rinsing the tank out with gasoline.

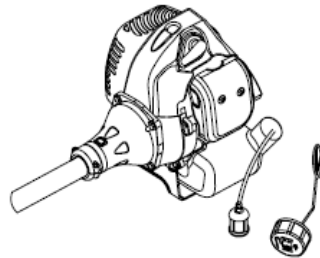

**Check Spark Plug:**

1. Do not attempt to remove the plug from a hot engine in order to avoid possible damage to the threads.
2. Clean or replace the plug if fouled with heavy oily deposits.
3. Replace the plug if the center electrode is worn rounded at the end.
4. Spark plug gap should be 0.6-0.7 mm (0.023"-0.028").
5. Fastening torque: 145-155 kg.cm (125-135 in.lb)

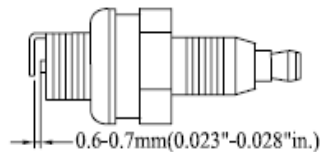

Part No	Part Name	Part No	Part Name
B-33	Screw M5 x 12 (Star)	B-87	Screw M5 x 30(Allen)
B-34	N/A	B-88	Cap, Lower
B-35	Nut M6	B-89	Nut M5 (Hex)
B-36	Screw M6 x 16 (Hex)	B-90	N/A
B-37	N/A	B-91	N/A
B-38	Engine base	B-92	Screw M6 x 25 (Hex)
B-39	Front support COMP.	B-93	Safety Guard Bracket
B-40	Back support COMP.	B-94	Safety Guard
B-41	Gear Case ASS'Y	B-95	Throttle Wire ASS'Y
B-42	Stop Ring 24 Inner	B-96	Lever ASS'Y
B-43	Stop	B-97	Screw M5 x 20(Star)
B-44	Bearing 6109-2RZ/P5	B-98	N/A
B-45	Pinion	B-99	N/A
B-46	Steel Plate Cap	B-100	N/A
B-47	Screw M5 x 12 (Star)	B-101	N/A
B-48	Gear Case	B-102	N/A
B-49	Screw M6 x 12 (Hex)	B-103	N/A
B-50	Blade Cover	B-104	Screw M5 x 20(Star)
B-51	Bearing 6000/P5	B-105	N/A
B-52	Gear	B-106	Nut M5
B-53	Gear Shaft	B-107	N/A
B-54	Bearing 6202-2RZ/P5	B-108	Switch On/Off

Part No	Part Name	Part No	Part Name
B-01	Shoulder Belt Assy	B-55	Stop Ring 32 Inner
B-02	Holder, Lower	B-56	Holder A
B-03	Shoulder Plate COMP	B-57	Holder B
B-04	Holder, Upper	B-58	Bolt Protection Cover
B-05	Washer	B-59	S. Washer 8
B-06	Washer	B-60	Bolt (Left thread)
B-07	Screw M5 x 16 (Hex)	B-61	Screw M5 x 20 (Allen)
B-08	Fuel	B-62	Wire Clamp Band
B-09	Spring (Fuel pipe)	B-63	Wire Sleeve
B-10	Fuel	B-64	Clutch COMP.
B-11	Clip (Fuel)	B-65	Lock Pin
B-12	Fuel	B-66	Clutch Case/Linker
B-13	Fuel	B-67	Spring (Lock Pin)
B-14	Fuel	B-68	Stop Ring 5 Outer
B-15	N/A	B-69	Clutch Drum
B-16	N/A	B-70	Stop Ring 35 Inner
B-17	N/A	B-71	Bearing 6202-2RZ/P6
B-18	N/A	B-72	Stop Ring 15 Outer
B-19	Filter	B-73	Flexible Liner COMP.
B-20	Washer (Filter Net)	B-74	N/A
B-21	Tank holding metal COMP.	B-75	Flexible Shaft/Inner Cable
B-22	Nut	B-76	Screw M5 x 30(Star)
B-23	Screw M5 x 12 (Allen)	B-77	Joint Pipe
B-24	Shoulder Frame COMP.	B-78	Handle Bush Cover
B-25	Spring (Bedding)	B-79	Adapter Comp.
B-26	Screw M6 x 16 (Hex)	B-80	Outer Pipe With Bush
B-27	Washer	B-81	Drive Shaft
B-28	Washer	B-82	Oil-bearing
B-29	Nut M6 (Flanged Hex)	B-83	Rubber Bush (Outer Pipe)
B-30	Down base	B-84	Holder ASS'Y
B-31	Nut M10 (Flanged Hex)	B-85	Holder Rubber Cover
B-32	Nut M5 (Hex)	B-86	Holder

**Gear case:**

The reduction gears are lubricated by multipurpose, lithium based grease in the gear case. Supply new grease every 25 hours of use or more often depending on the job condition.

Remove the bolt of the grease nipple and bolt opposite side of the grease nipple. Install new grease into the grease nipple to arrange for old grease to exit from the opposite side.

**Muffler:**

Inspect periodically, the muffler for loose fasteners, any damage or corrosion. If any sign of exhaust leakage is found, stop using the machine and have it repaired immediately.

Note that failing to do so may result in the engine catching on fire.

**Procedures to be performed after every 100 hours of use:**

1. Remove the muffler, insert a screwdriver into the vent, and wipe away any carbon buildup. Wipe away any carbon buildup on the muffler exhaust vent and cylinder exhaust port at the same time.
2. Tighten all screws, bolts, and fittings.
3. Check to see if any oil or grease has worked its way in between the clutch lining and drum, and if it has, wipe it away using oil-free, lead-free gasoline.

**Maintenance Schedule**

Machine parts	Action	Each time before use	Operation time(hour)	
			10	20
Bolt, screw cap, pin	Check, tighten		√	
Air filter	Clean or replace			√
Fuel filter	Replace		√	
Spark plug	Clean/adjust/replace		√	
Fuel tube	Check, or replace if necessary	√		
Entire machine	Check, or clean if necessary	√		
Operating handle	Check its function	√		
Cutting tool	Check, or sharpen or replace if necessary	√		

**TRANSPORT AND STORAGE**

**Transport and handling:**

1. The engine should be turned off when the unit is moved between work areas.
2. After the engine has stopped, the muffler is still hot, never touch hot parts such as the muffler.
3. Confirm that the fuel has not leaked from the tank.
4. Allow the engine to cool, empty the fuel tank and secure the unit from moving before transporting in a vehicle, if the blade is fitted, always use the blade guard.
5. Please empty the fuel tank before transporting, to avoid the engine leakage.
6. For avoiding the cutting attachment damage the brush cutter and people, please remove the cutting attachment, and at the same time, restore the brush cutter to factory state and then casting all parts into the package.
7. Before transporting, all parts should be packed and validated safe.

**Installing Blade Guard:**

Open the blade guard and install on the blade, then put into the guard notch.

**Note:** Always place the blade guard on the blade when the unit is not in use. Remove the blade guard before using the unit. If not removed, the blade guard could become a thrown object as the blade begins to turn.



**Extended Storage:**

1. Inspect, clean and repair unit if necessary
  2. Remove all fuel from tank.
  3. Start engine-This will consume all the fuel in fuel line and carburetor.
  4. Remove spark plug and pour one tea spoon of clean motor oil into the spark plug.
  5. Store in clean, dry, dust free area.
- Note:** Do not store in a closed area where fuel vapors can reach an open flame from hot water heaters, hot furnaces, etc. Store in a locked well-ventilated area only.

**BODY PARTS DIAGRAM & LIST-KK-SBC-4302**

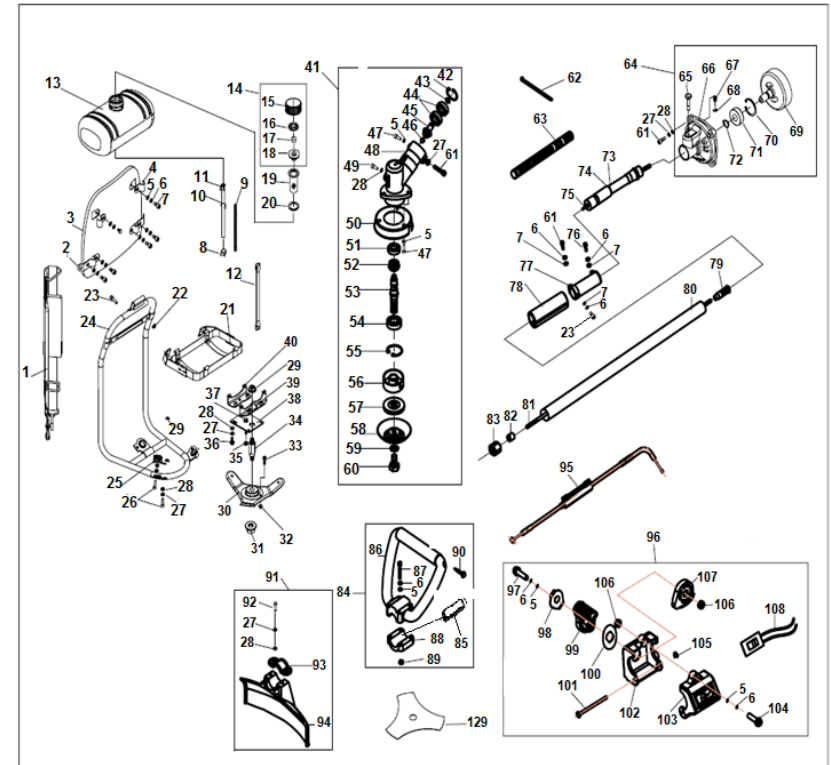



Part No	Part Name	Part No	Part Name
E-01	Gasket Insulator	E-38	Washer A
E-02	Cover	E-39	Clutch Bolt
E-03	Insulator	E-40	Fan
E-04	Screw M5 x 25 (Star)	E-41	Bolt
E-05	Carburetor	E-42	Washer 5 Spring
E-5-1	Fuel Cock	E-43	Washer 5 Plain
E-06	Stop	E-44	Screw M5 x 12
E-07	Filter	E-45	Circlip (Piston Pin)
E-08	Cleaner Cover	E-46	Piston
E-09	N/A	E-47	Piston Pin
E-10	Washer	E-48	Piston Ring
E-11	Washer	E-49	Gasket (Cylinder)
E-12	Screw M4 x 25 (Star)	E-50	Cylinder
E-13	Gasket Starter	E-51	Screw M5 x 20(Allen)
E-14	Start Claw	E-52	Guide Cover Assy
E-15	Start	E-53	Stand (Fuel Pipe)
E-16	Start	E-54	Gasket Guide Cover
E-17	Stop	E-55	Screw M5 x 20 (Star)
E-18	Oil-seal	E-56	Spark Plug
E-19	Crank	E-57	Spring (Spark Plug)
E-20	Gasket Crankcase	E-58	Spark Plug Cap
E-21	Bearing	E-59	Gasket (Muffler)
E-22	Crank	E-60	Muffler
E-23	Key 3X5X13 (Crankshaft)	E-61	Bolt
E-24	Bearing (Piston Pin)	E-62	N/A
E-25	Pin B5 x 12	E-63	N/A
E-26	Crank	E-64	Washer 8 Plain
E-27	Pin B4xJO	E-65	Washer 8 Spring
E-28	Oil-seal	E-66	Starter Assy
E-29	Screw M5 x 30 (Allen)	E-66-1	Screw-Ratchet
E-30	Fly Wheel	E-66-2	Ratchet-Starter
E-31	NUT M8	E-66-3	Ratchet -Spring
E-32	Ignition Coil COMP.	E-66-4	Rope Reel
E-33	Cord	E-66-5	Recoil Spring
E-34	Bolt M5 x 20 (Hex)	E-66-6	Starter Cover
E-35	Washer B	E-66-7	Starter Rope
E-36	Spring (Clutch)	E-66-8	Starter Handle
E-37	Clutch Shoe Assy	E-38	Washer A

## TROUBLESHOOTING

Problem	Probable cause	Action to be taken
Engine does not start.	Start sequence error	Note specification about start machine in this operation instruction.
	Carburetor mixed fuel adjustment error	Adjust carburetor by special repair shop
	Carbon deposit in spark plug	Clean, adjust or replace spark plug
	Fuel filter jam	Replace or clean fuel filter
Engine has started, but the machine does not run in full power.	Choke level position error	Adjust choke level to "Run" position.
	Air filter is dirty	Clean, adjust or replace spark plug
	Carburetor mixed fuel adjustment error	Adjust carburetor by authorized service personnel
Engine trembles and stop.	Carburetor mixed fuel adjustment error	Adjust carburetor by authorized service personnel
	Carbon deposit in spark plug	Clean, adjust or replace spark plug
No power when loading.	Carburetor mixed fuel adjustment error	Adjust carburetor by authorized service personnel
Too much exhaust gas/fuel dust	Carburetor mixed fuel adjustment error	Adjust carburetor by authorized service personnel
	Fuel mix error	Use 2-stroke mixed fuel in 40:1 mixture ratio

## TECHNICAL SPECIFICATIONS

	Model	KK-BC-8640/8647 KK-TC2-8641	KK-BC-7640	KK-BC2-8665	KK-SBC-4302	KK-SBC-3404	KK-BC4-8634/8637
Main unit	RPM/ Output pressure	7000/9000		7500	6500 / 7500		
	Blade rotation direction	Counter clockwise(seen from the top)					
	Type of handle	Double grip					
Engine	Engine Type	Air-cooled, 2 stroke, vertical piston valve, gasoline engine.			Air-cooled, 4-stroke, vertical piston valve, Gasoline engine.		
	kW (hp)	1.25kW (1.7 hp)	2.2kW (3hp)	1.5kW(2hp)	0.9kW (1.2hp)		
	CC	40	63.3	27	34		
	Consumption/Maximum output	600ml/hr			500ml / hr		
	Carburetor	Diaphragm-type					
	Method of starting	Recoil type					
	Fuel used	Petrol mixed with lubricating oil(40:1)			Petrol		
	Fuel tank capacity(L)	1.1	1.3	1.1	0.7		
Length of main pipe section(mm)		1255	1500				
Weight of the machine(kg)	11	10.8	7.5			7.5	
Length of drive shaft section(mm)	1522	1290	3937	1535	3352		1522

Technical data is subject to change without prior notice.

## ENGINE-PARTS DIAGRAM & LIST-KK-SBC-4302

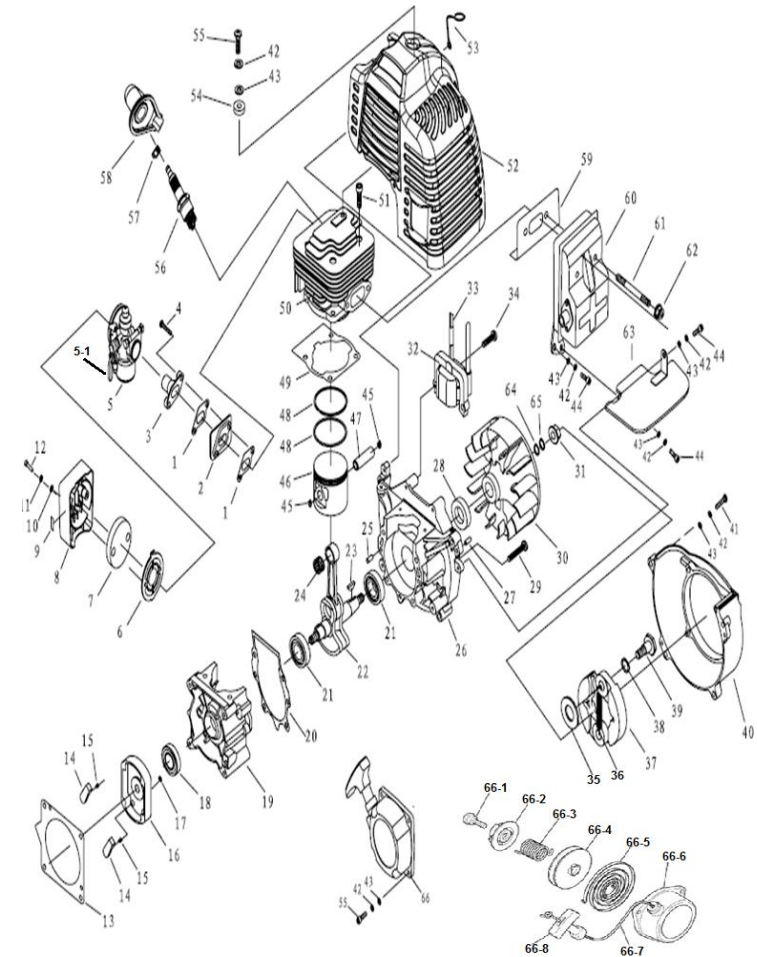

Part No	Part Name	Part No	Part Name
B6	Steel Plate Cap-Pinon	B46	Holder Assy
B7	Screw M5x12 –Hex	B47	Screw M5x20 (STAR)
B8	Gear Case	B48	N/A
B9	Grease Bolt M8x12 –Hex	B49	Nut 5
B10	Blade Cover-Plastic	B50	Harness Assy
B11	Bearing6000	B51	Lever Assy
B12	Gear	B52	Screw M5x30-Allen
B13	Gear Shaft	B53	Washer 5-Plain
B14	Bearing 6202 -2RZ	B54	Buy #51 Lever Assy
B15	Stop Ring 35-Inner	B55	Buy #51 Lever Assy
B16	Holder A	B56	
B17	Holder B	B57	
B18	Cover-Metal	B58	
B19	Washer 8-Star	B59	Box Up-Lever Assy
B20	Bolt M8x12 Left thread	B60	Screw M5x30 star
B21	Screw M5x12 –Star	B61	Switch On/ Off
B22	Washer 6-Spring	B62	Wire Sleeve
B23	Screw M6x20 -Allen	B63	Throttle Cable
B24	Bearing 6001	B64	N/A
B25	N/A	B65	Box Down-lever Assy
B26	Rubber Bush-Outer Pipe	B66	N/A
B27	Oil bearing-Outer Pipe	B67	Right Handle
B28	Drive Shaft	B68	Screw M5x16 -Allen
B29	Outer Pipe-With Bushes	B69	Cap Up-Handle
B30	Clutch Comp-Assy	B70	Bracket-Handle
B31	Clamp A	B71	left handle
B32	Washer 5-Plain	B72	Handle Rubber Cover
B33	Washer 5-Spring	B73	Screw M6x20 -Allen
B34	Screw M5x20 -Allen	B74	Cap Lower-Handle
B35	Screw M5x10 -Allen	B75	N/A
B36	Rubber Cover A	B76	Screw M6x20 -Allen
B37	Rubber Cover B	B77	Safety Guard Bracket-Small/Big
B38	Linker	B78	Safety Guard -Small/Big
B39	Stop Ring 15-Outer	B79	Blade
B40	Bearing 6202-2Rz	B80	Tap And Go Stud

**ENGINE-DIAGRAM & PARTS LIST-KK-BC2-8665**

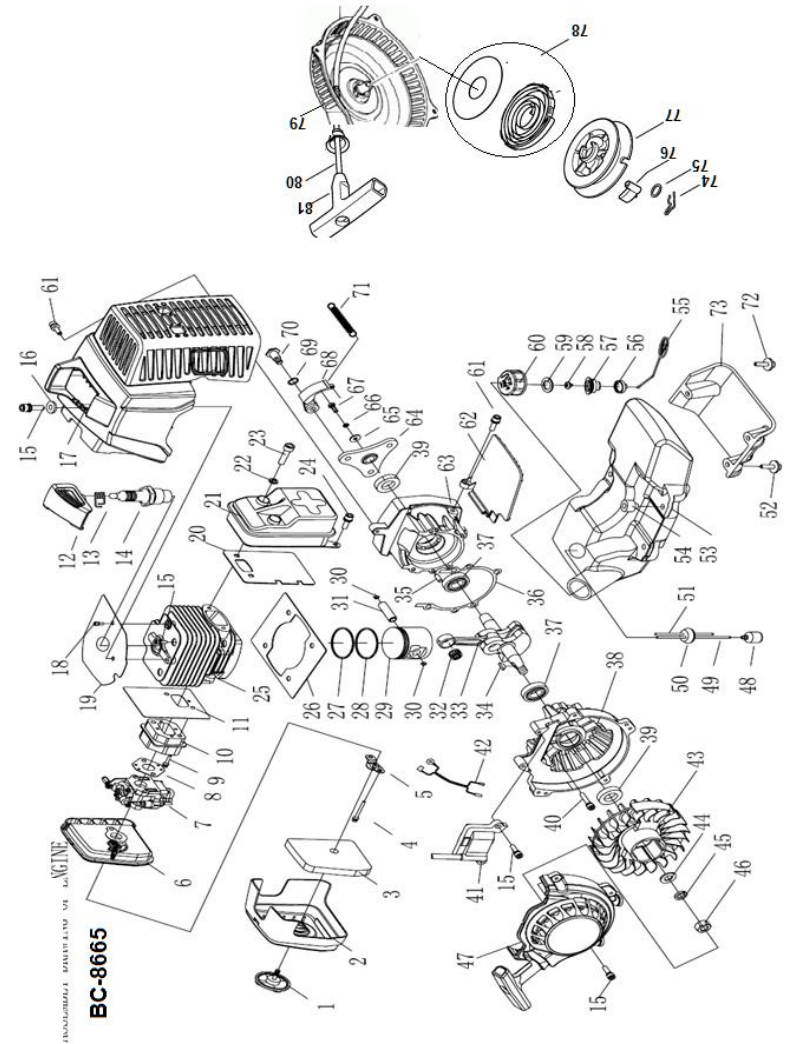

Part No	Part Name	Part No	Part Name
E-1	Screw (AIR FILTER)	E-42	Cord Comp. (Coil)
E-2	Cleaner Outside Cover	E-43	Fly Wheel
E-3	Filter Net	E-44	Washer 10 Plain
E-4	Screw M5 x 55 ALLEN	E-45	Washer 10 Spring
E-5	Baffle	E-46	Nut M10x1.25
E-6	Cleaner inside cover	E-47	Starter Assy
E-7	Carburetor	E-48	Filter (Petrol)
E-8	Gasket (Carburetor)	E-49	Fuel pipe 3 x 1.25 x 260 (long)
E-9	Screw M5 x 30 ALLEN	E-50	Plug / Fuel Pipe Grommet
E-10	Admitting Pipe / Insulator	E-51	Fuel pipe 3 x 1 x 90 (Short)
E-11	Gasket (Insulator)	E-52	Screw M5 x 30 ALLEN
E-12	Cap (Spark Plug)	E-53	Fuel Tank
E-13	Spring (Spark Plug)	E-54	Gasket (Fuel Tank)
E-14	Spark Plug	E-55	N/A
E-15	Screw M5 x 20 ALLEN	E-56	N/A
E-16	Gasket (Guide Cover)	E-57	N/A
E-17	Guide Cover Ass'	E-58	N/A
E-18	Screw M5 x 10 ALLEN	E-59	Gasket (Fuel Tank Lid)
E-19	Clapboard (Guide Cover)	E-60	Fuel Tank Lid Assy
E-20	Gasket Muffler)	E-61	Screw M5 x 16 ALLEN
E-21	Muffler	E-62	Clapboard (Fuel Tank)
E-22	Washer 8 Spring	E-63	Crank Case (Small)
E-23	Screw M8 x 30-10. 9 ALLEN	E-64	Chassis (Clutch)
E-24	Screw M5 x 12 ALLEN	E-65	Washer 6 Plain
E-25	Cylinder	E-66	Washer 6 Spring
E-26	Gasket (Cylinder)	E-67	Bolt 6x15 HEX
E-27	Piston Ring (1 ST)	E-68	Clutch Shoe
E-28	Piston Ring (2 ND)	E-69	Washer (Clutch)
E-29	PISTON	E-70	Clutch Step Screw
E-30	RING / Circlip (Piston Pin)	E-71	Clutch Spring
E-31	PISTON PIN	E-72	Screw M5 x 30 ALLEN
E-32	Bearing Needle (Piston Pin)	E-73	Stand (Fuel Tank)
E-33	Crank Shaft Assy	E-74	Lock (Ratchet)
E-34	KEY3x13 (Crankshaft)	E-75	Washer (Ratchet)

## BODY PARTS DIAGRAM & LIST-KK-BC-7640/8640/8647

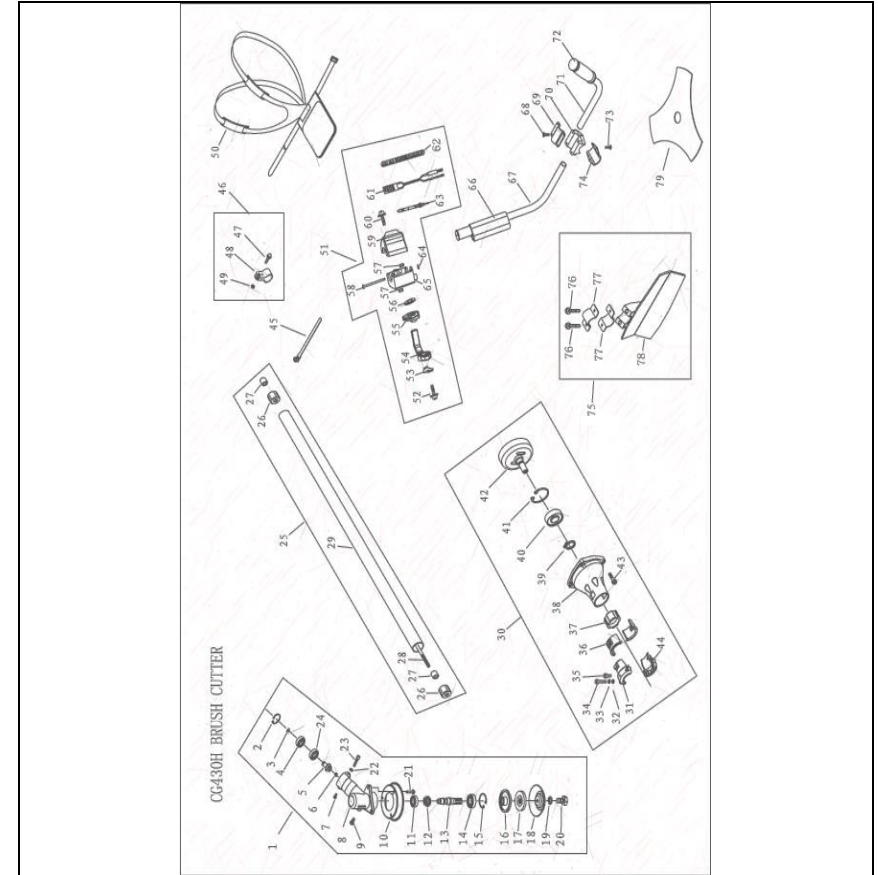

Part No	Part Name	Part No	Part Name
B1	Gear Case Assy	B41	Stop Ring 35-Inner
B2	Stop Ring 28-Inner	B42	Clutch Drum
B3	Stop Ring 12-Outer	B43	Screw M6x20 -Allen
B4	Bearing 6001 2RS	B44	Clamp B
B5	Pinion	B45	Wire Clamp

Part No	Part Name	Part No	Part Name
E8	Air Filter Sponge	E52	Spark Plug
E9	Air Cleaner outside cover	E53	Spring-Spark Plug
E10	Screw-Air Filter	E54	Cap-Spark Plug
E11	Gasket -Starter	E55	Gasket -Muffler
E12	Start Claw	E56	Muffler
E13	Claw Spring	E57	Screw- M6x55 Allen
E14	Start Reel	E58	Nut M6 -Flanged Hex
E15	E-Ring 4	E59	Clip Board
E16	Oil Seal Small-12x22x7	E60	Washer 8-Plain
E17	Crank Case Small	E61	Washer 8-Spring
E18	Gasket-Crank Case	E62	Starter-Assy
E19	Bearing 6202	E63	Screw 4.2x12-Choker
E20	Crank Shaft Assy	E64	Petrol Filter
E21	Key3x5x13-CrankShaft	E65	Fuel Pipe-Long
E22	Needle Bearing -Piston Pin	E66	Fuel pipe Grommet
E23	Pin B5x12-Crank Case	E67	Fuel pipe-Short
E24	Crank Case-Big	E68	Screw M5x16-Star
E25	Pin B4x10-Fan Cover	E69	Fuel Tank
E26	Oil Seal Big-15x30x7	E70	Buy #76 Fuel Tank Lid Comp
E27	Screw M5x30 -Allen	E71	Gasket-Fuel Tank Lid
E28	Fly Wheel	E72	Buy #76 Fuel Tank Lid Comp
E29	Nut M8 -Flanged Hex	E73	
E30	Ignition Coil	E74	
E31	Cord Comp-Wire	E75	
E32	Screw M5x20 - Hex	E76	Fuel Tank Lid Comp
E33	Washer B-Clutch	E77	Cushion -Fuel tank
E34	Spring-Clutch	E78	Cushion-Stand
E35	Clutch Shoe Assy	E79	Stand -Fuel Tank
E36	Washer A-Clutch	E80	Screw M 5x16-Star
E37	Clutch Bolt	E81	Screw-Ratchet
E38	Fan Cover	E82	Ratchet-Starter
E39	Screw M5x25 -Hex	E83	Ratchet -Spring
E40	Screw M5x12 -Star	E84	Rope Reel
E41	Circlip -Piston Pin	E85	Recoil Spring
E42	Piston	E86	Starter Cover
E43	Piston Pin	E87	Starter Rope
E44	Piston Ring	E88	Starter Handle

Part No	Part Name	Part No	Part Name
E-35	Pin 4h8 x 10	E-76	Ratchet
E-36	Gasket (Crankcase)	E-77	Rope reel
E-37	Bearing 6202/P6	E-78	Recoil Spring
E-38	Crank Case (Big)	E-79	Starter Cover
E-39	Seal 15x25x7	E-80	Starter Rope
E-40	Screw M5 x 30 ALLEN	E-81	Starter Handle
E-41	Coil (Ignition)		

**BODY PARTS-KK-BC-8665**

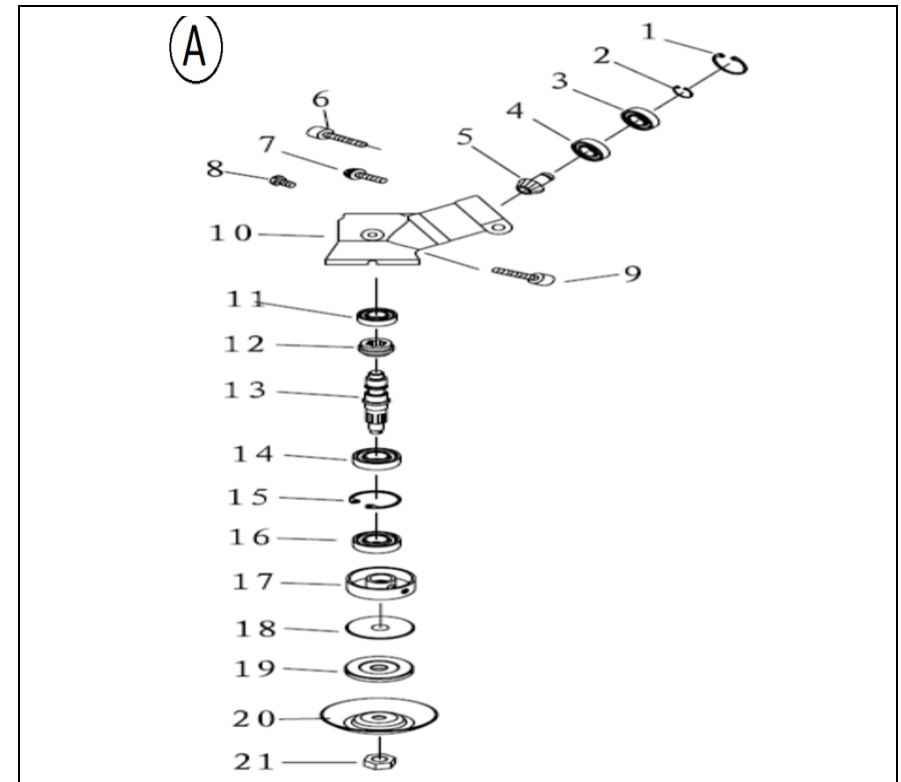

Part No	Part Name	Part No	Part Name
B-A	Gear Case Assy	B-A11	Bearing 6000/P5
B-A01	Stop Ring 28 (Inner)	B-A12	Gear
B-A02	Stop Ring 12 (Outer)	B-A13	Gear Shaft
B-A03	Bearing 6001-2RS/P5	B-A14	Bearing 6202-2RS/P5
B-A04	Bearing 6001/P5	B-A15	Stop Ring 35 (Inner)
B-A05	Pinion	B-A16	Oil-seal 20X35X6
B-A06	Screw M6 X 35 Allen	B-A17	Holder A
B-A07	Screw M5 X 12 Allen	B-A18	Washer (Gear Box)
B-A08	Screw M5X8 Allen	B-A19	Holder B
B-A09	Bolt M6X8 (Grease nipple)	B-A20	Cover (Metal)
B-A10	Gear Case	B-A21	NUT (Left Thread)

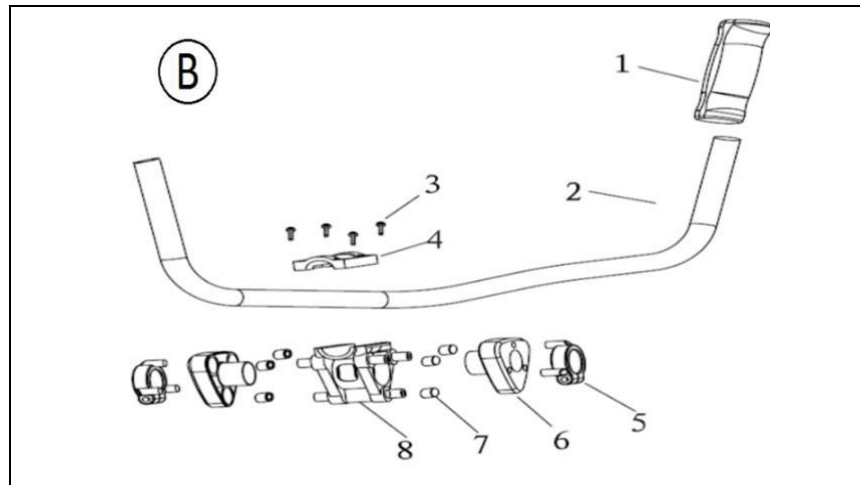

Part No	Part Name	Part No	Part Name
B-B01	Rubber Ringer	B-B05	Clamp Ring
B-B02	HANDGRIP / Handle	B-B06	Linker (Handle)
B-B03	Screw M5*25 Allen	B-B07	Rubber (Handle Linker)

**ENGINE- DIAGRAM & PARTS LIST-KK-BC-7640/8640/8647**

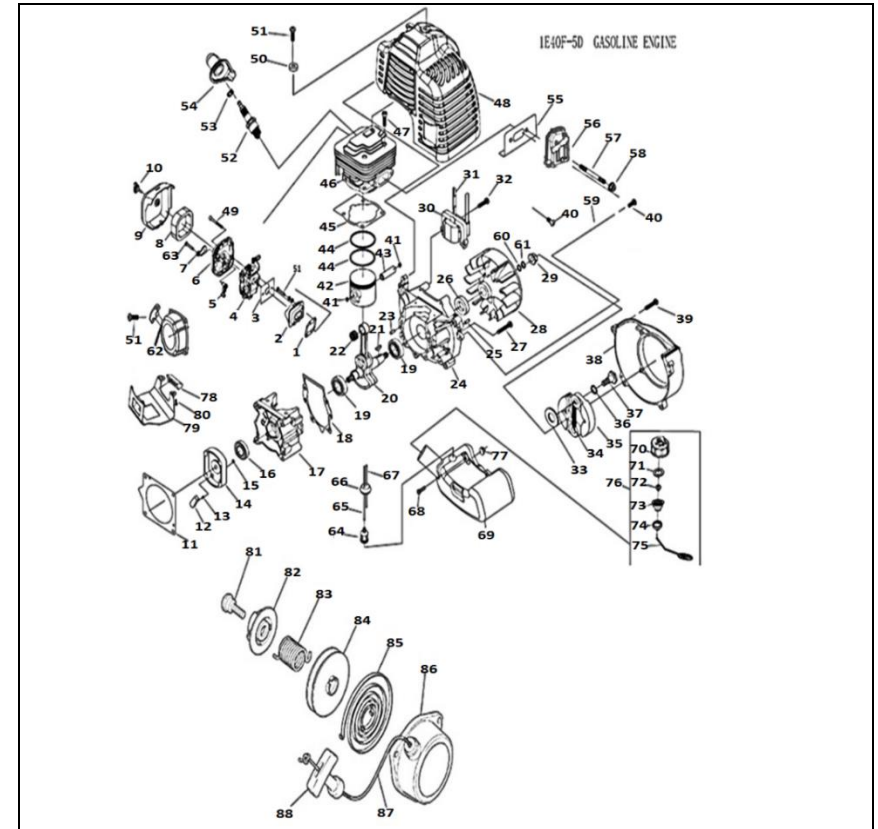

Part No	Part Name	Part No	Part Name
E1	Gasket-Insulator	E45	Gasket-Cylinder
E2	Insulator	E46	Cylinder
E3	Gasket-Carburetor	E47	Screw M5x20 -Allen
E4	Carburetor	E48	Guide Cover -Assy
E5	Choker Handle	E49	Screw M5x50- Star
E6	Air Cleaner Inside Cover	E50	Gasket-Guide Cover
E7	Choker	E51	Screw M5x20-Star

Part No	Part Name	Part No	Part Name
6	Screw M6x20-Allen	F	Safety Guard Assy
7	Washer 6-Spring	49	Screw M5x12-Allen
8	Screw M5x12-Hex	50	Screw M5x10-Allen
9	Grease Bolt-M6x12	51	Safety Guard Bracket
10	Gear Case	52	Safety Guard
11	Blade Cover	53	Scerw-ST4.2x16
12	Bearing 6000-2 RS	54	Guard
13	Gear	55	Washer 5-Spring
14	Gear Shaft	56	Blade-Rope Cutter
15	Bearing 6002-2 RS	57	Blade Cover
16	Stop Ring 32-Inner	G	Lever Assy
17	Holder-A	58	Box Left -Lever Assy
18	Holder-B	59	Switch On/Off
19	Washer 8-Star	60	Throttle Cable
20	Nut M8-Left Thread	61	<b>Buy #G LEVER ASSY</b>
21	Pin 2x16-Blade Cover	62	
B	Harness Assy	63	<b>Buy #G LEVER ASSY</b>
C	<b>N/A</b>	64	
22	Rubber Bush-Outer Pipe	65	<b>Buy #G LEVER ASSY</b>
23	Oil Bearing-Outer Pipe	66	
		67	
24	Drive Shaft	I	Clutch Comp Assy
25	Outer Pipe With Bushes	68	Clutch Drum
		69	Stop Ring 35-Inner
D	Holder Assy	70	Bearing 6202-2RS
26	<b>Buy #D Holder Assy</b>	71	Stop Ring 15-Outer
27		72	Linker
28		73	Rubber Cover-Lever
29		74	Screw M5x25-Allen
30	Handle Rubber Cover	75	Washer 5-Plain
31	Right Handle	76	Clamp-B
32	Screw M5x16-Allen	77	Clamp-A
33	Cap Up-Handle	78	Washer 5-Plain

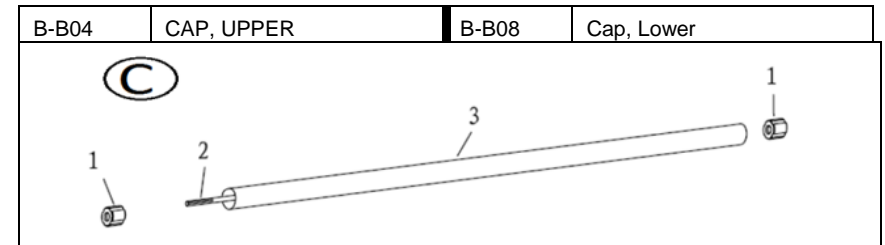

Part No	Part Name	Part No	Part Name
B-B04	CAP, UPPER	B-B08	Cap, Lower
B-C	N/A	B-C02	Drive Shaft
B-C01	Drive bearing	B-C03	Outer Pipe With Bush

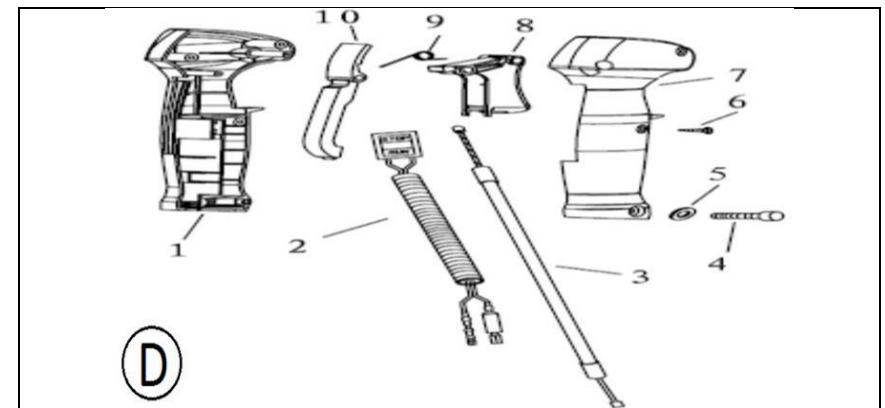

Part No	Part Name	Part No	Part Name
B-D	Lever Assy	B-D06	N/A
B-D01	N/A	B-D07	N/A
B-D02	Stop Button Comp.	B-D08	N/A
B-D03	Cable Comp.	B-D09	Spring (Lever Assy)
B-D04	BOLT M5*30 (Star)	B-D10	N/A
B-D05	WASHER 5 Plain		

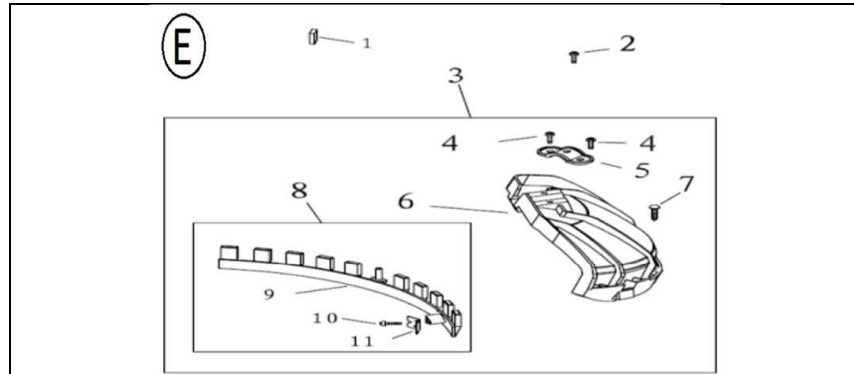

Part No	Part Name	Part No	Part Name
B-E01	N/A	B-E07	Screw ST4.2X16
B-E02	BOLT M5*10	B-E08	Guard Assy
B-E03	Safety Guard Assy	B-E09	Guard
B-E04	Screw M5*12 Allen	B-E10	Screw ST4.2X16 Star
B-E05	Safety Guard Bracket	B-E11	Blade
B-E06	Safety Guard		

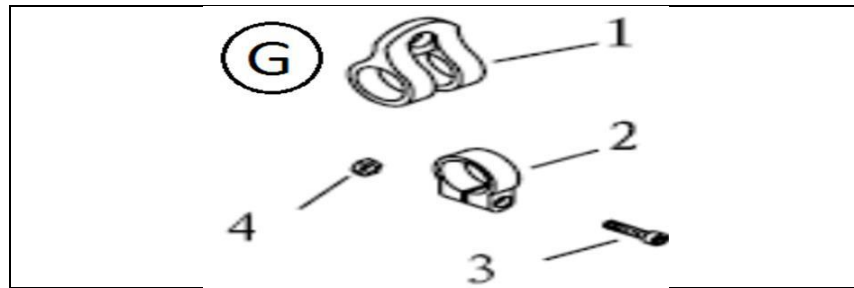

Part No	Part Name	Part No	Part Name
B-G	Holder Assy	B-G03	Screw M5X20
B-G01	N/A	B-G04	Nut M5
B-G02	N/A		

**BODY PARTS DIAGRAM & PARTS LIST-KK-BC4-8634/8637**

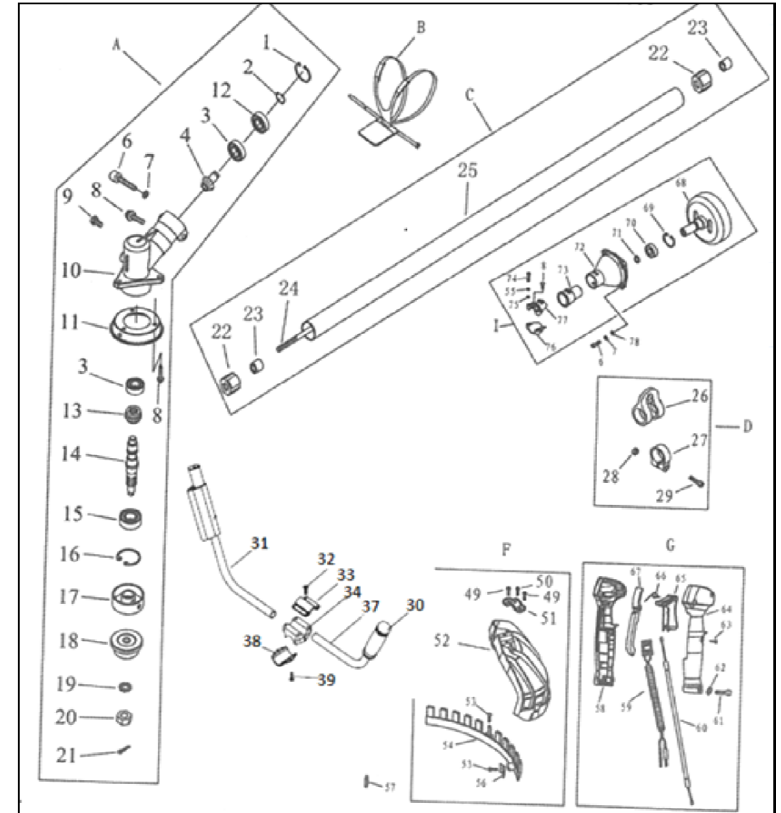

Part No	Part Name	Part No	Part Name
A	Gear Case Assy	34	Bracket-Handle
1	Stop Ring 26-Inner	35	N/A
2	Stop Ring 10-Outer	36	
3	Bearing-6000	37	Left Handle
4	Pinion	38	Cap Lower-Handle
5	N/A	39	Screw M6x20-Allen



34	Below Rocker	97	Oil Pipe
35	Jib Sealing-Gasket	98	Tie In-Oil Pipe
36	Cam Wheel	99	Ball Baffler
37	Pin-Below Rocker	100	Ball 5
38	Output Valve	101	O Ring-Oil Pipe
39	Tie In-	102	Screw M5x35-Allen
40	Rocker Pin	103	Clip-Oil Pipe
41	Copper Pipe-(Breather)	104	Bearing 6201-2 RS
42	Cylinder Cover	105	Gear
43	Nut M6-Hex	106	Oil Seal-10x20x5
44	Throttle Cable-Adjuster	107	Start Reel
45	Insulator	108	Starter Assy
46	Gasket-Insulator	109	Plug
47	Sealed Cowling	110	Fuel Pipe Short
48	Gasket-Sealed Cowling	111	Fuel Pipe Grommet
49	Gasket-Cylinder Cover	112	Petrol Filter
50	Spark Plug	113	Fuel Tank Lid
51	Spark Plug Protective Cover	114	Gasket-Fuel Tank Lid
52	Screw M5x10-Star	115	N/A
53	Guide Cover Assy	119	Fuel Tank
54	Gasket-Muffler	120	Gasket
55	Muffler	121	Metal Tube-Tank
56	Muffler Cover	122	Heat Insulation Mat
57	Washer 5-Plain	123	Stand-Fuel Tank
58	Screw M5x6-Star	124	Screw M5x30-Star
59	Clip-Pipe	125	Fuel Pipe Long
60	Screw M5x40-Allen	126	Fly Wheel
61	Clutch Bolt		

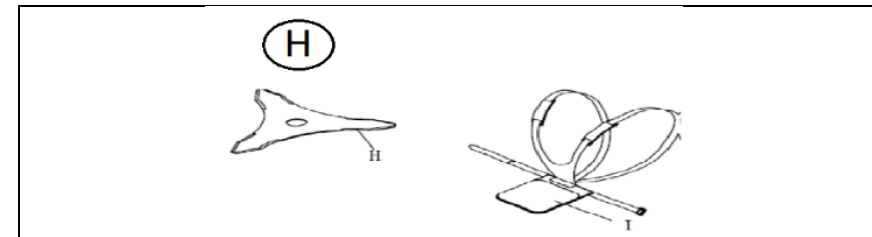

Part No	Part Name	Part No	Part Name
H	N/A	B-I 01	Harness Assy

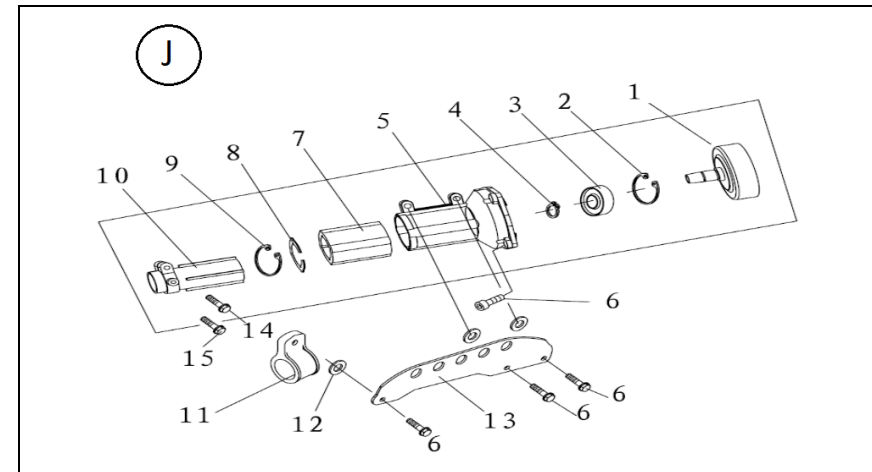

Part No	Part Name	Part No	Part Name
B-J	Clutch Comp.	B-J08	Washer (Clutch Case)
B-J01	Clutch Drum Comp.	B-J09	Stop Ring 48 (Inner)
B-J02	Stop Ring 35(Inner)	B-J10	Linker (For Pipe)
B-J03	Bearing 6202-2RS/P5	B-J11	Hang Ring
B-J04	Stop Ring 15(Outer)	B-J12	Washer (Flat)
B-J05	Clutch Case	B-J13	Hang Handle
B-J06	Bolt M6X20 Allen	B-J14	Bolt M6X30 Allen
B-J07	Rubber (Clutch Case)	B-J15	Bolt M5X12 Allen

**ENGINE-PARTS DIAGRAM & LIST-KK-BC4-8634/8637**

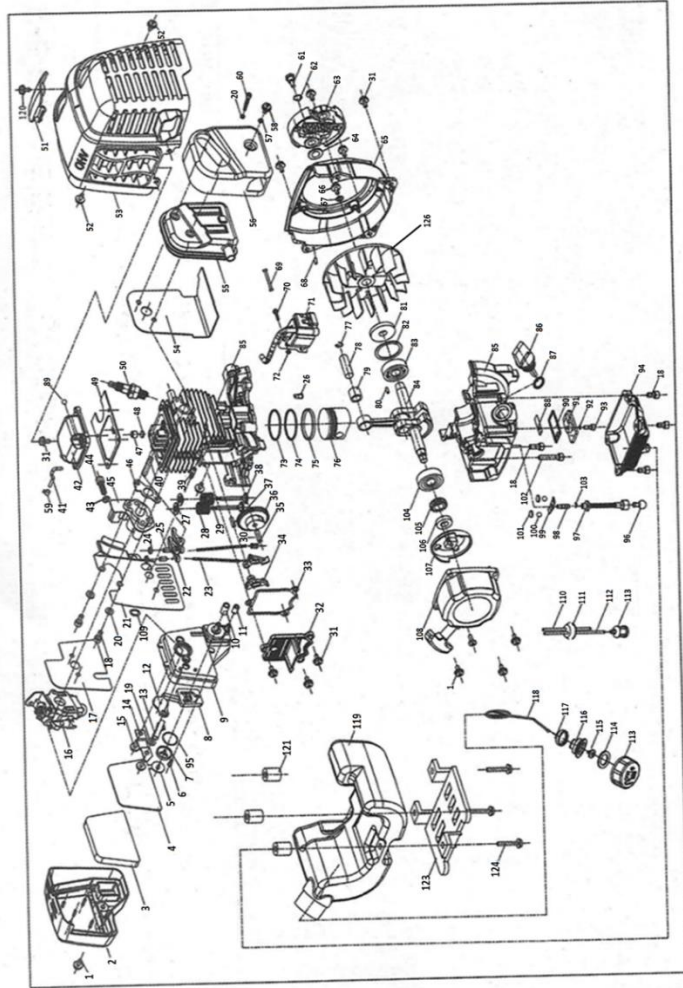

Part No	Part Name	Part No	Part Name
1	Screw M5x16-Star	62	Washer A-Clutch
2	Air Cleaner Outside Cover	63	Clutch Shoe Assy
3	Air Filter Sponge One	64	Washer B-Clutch
4	Air Filter Sponge Two	65	Fan Cover
5	Air Check Valve-1	66	Screw M6x16-Hex
6	Air Check Valve-2	67	Washer-Fly Wheel
7	Air Check Valve Bracing	68	Pin-B4x8
8	Separator	69	Cord Comp-Wire
9	Air Cleaner Inside Cover	70	Screw M4x16-Hex
10	Returning Oil Pipe	71	Ignition Coil
11	Wind Pipe	72	Head Insulation Mat-Coil
12	Choker	73	Piston Rings Set #73,74&75
13	Choker Handle	76	Piston
14	Baffle	77	Circlip-Piston Pin
15	Screw M5x68-Star	78	Piston Pin
16	Carburetor	79	Needle Bearing-Piston Pin
17	Gasket-Carburetor	80	Key C3x8-Crank Shaft
18	Screw M5x16-Allen	81	Oil Seal-12x32x5.5x3
19	Gasket-Rubber	82	Check Ring
20	Washer 5-Plain	83	Bearing-6201
21	Eliminating Vane	84	Crank Shaft Assy
22	Rocker	85	Cylinder & Crankcase
23	Jib	86	Oil Dip Stick
24	<b>Jib Seat &amp; Adjusting Nut</b>	87	O Ring 14x3-Oil Dip Stick
25		88	Reed
26	Air Check valve	89	Ball-4
27	Spring Seat	90	Gasket-Board
28	Valve Spring	91	Board
29	Input Valve	92	Washer 4-Spring
30	Pin-Cam Wheel	93	Screw M4x10-Allen
31	Screw M5x16-Allen	94	Sump
32	Side Cover	95	O Ring-Air Filter
33	Gasket-Side Cover	96	Ball Oil Pipe